

JVC



COMPACT COMPONENT SYSTEM 组合音响系统

MX-K55V

Consists of CA-MXK55V and SP-MXK55
由CA-MXK55V 及 SP-MXK55 组成



Video CD

PlayBack Control

VIDEO CD

SP-MXK55

CA-MXK55V

SP-MXK55

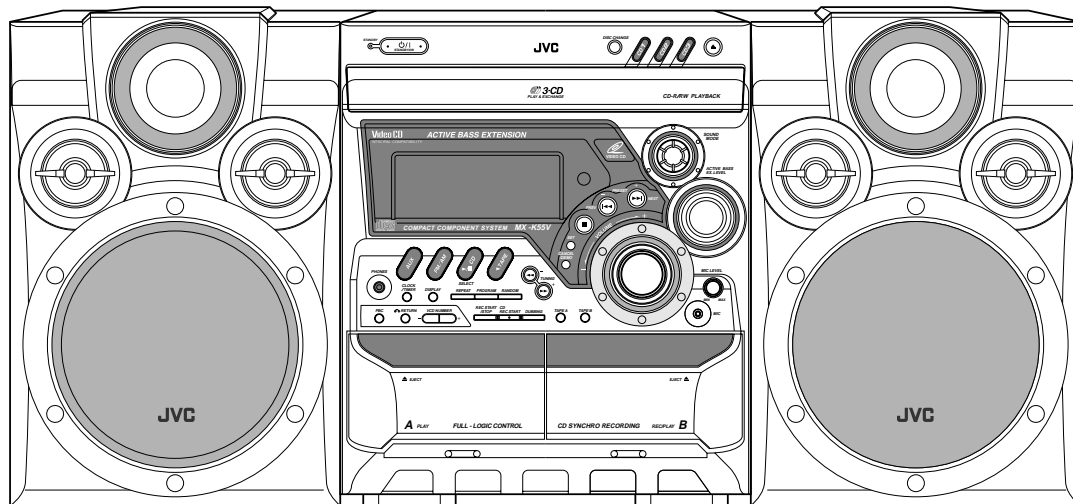

INSTRUCTIONS 使用说明书

For Customer Use:

Enter below the Model No. and Serial No. which are located either on the rear, bottom or side of the cabinet. Retain this information for future reference.

Model No. _____

Serial No. _____

LVT0699 -001A
[US]

Warnings, Cautions and Others

警告，注意及其他须知事项

Caution —  switch!

Disconnect the mains plug to shut the power off completely. The  switch in any position does not disconnect the mains line. The power can be remote controlled.

注意—  开关！

无论  开关在任何位置，电源线的电源还是没有被切断，若要将电源完全关闭，应把电源插头拔离插座。电源开关可用遥控器控制。

CAUTION

To reduce the risk of electrical shocks, fire, etc.:

1. Do not remove screws, covers or cabinet.
2. Do not expose this appliance to rain or moisture.

CAUTION

- Do not block the ventilation openings or holes. (If the ventilation openings or holes are blocked by a newspaper or cloth, etc., the heat may not be able to get out.)
- Do not place any naked flame sources, such as lighted candles, on the apparatus.
- When discarding batteries, environmental problems must be considered and local rules or laws governing the disposal of these batteries must be followed strictly.
- Do not use this apparatus in a bathroom or places with water. Also do not place any containers filled with water or liquids (such as cosmetics or medicines, flower vases, potted plants, cups, etc.) on top of this apparatus.

警告

为了减低触电，火灾等危险：

1. 请勿擅自卸下螺丝钉，盖子或机壳。
2. 切勿让本机受雨淋或置潮湿环境中。

注意

- 请勿堵塞通风口或通风孔。
(如果通风口或通风孔被报纸或布等堵塞，热量将无法散出。)
- 请勿在本设备上放置任何裸露的火源，如点燃的蜡烛。
- 处理废弃电池时，必须考虑环境问题，并严格遵守当地关于处理废弃电池的有关法律或规定。
- 请勿在浴室里或有水汽的地方使用本设备。亦请勿在本设备的上方放置任何装有水或液体的容器（如化妆品，药品，花瓶，花盆，杯子等）。

Caution: Proper Ventilation

To avoid risk of electric shock and fire, and to prevent damage, locate the apparatus as follows:

- 1 Front: No obstructions and open spacing.
- 2 Sides/ Top/ Back: No obstructions should be placed in the areas shown by the dimensions below.
- 3 Bottom: Place on the level surface. Maintain an adequate air path for ventilation by placing on a stand with a height of 10 cm or more.

注意：正确通风

为免发生触电和火警的危险，及防止本机受损，请将本机如下放置：

1. 前面： 没有障碍物及地方开阔。
2. 侧面/顶面/背面： 在图中所示范围中，不应放置任何障碍物。
3. 底部： 放置在水平面上。放置在一个高 10 厘米或以上的台上，以保持足够的通风道。

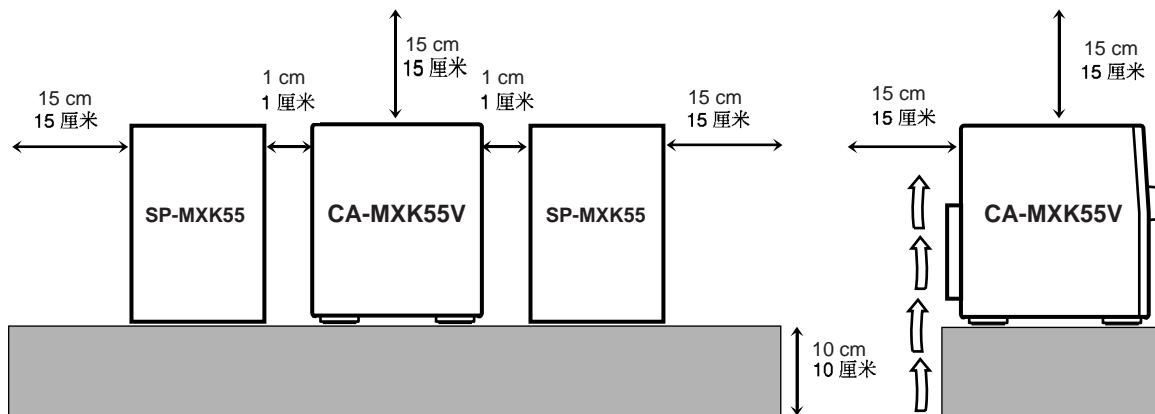

IMPORTANT FOR LASER PRODUCTS / 雷射产品的重要说明

REPRODUCTION OF LABELS / 标签内容说明

① CLASSIFICATION LABEL, PLACED ON REAR ENCLOSURE

① 分类标签，贴在机壳背后

② WARNING LABEL, PLACED INSIDE THE UNIT

② 警告标签，贴于机内

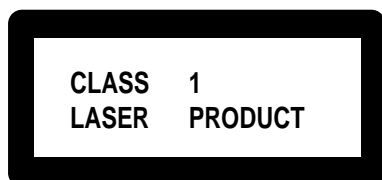

DANGER: Invisible laser radiation when open and interlock failed or defeated. AVOID DIRECT EXPOSURE TO BEAM. (e)

WARNING: Osynlig laserstrålning när denna del är öppnad och spärren är urkopplad. Betrakta ej strålen. (s)

ADVARSEL: Usynlig laserstrålning ved åbning, når sikkerhedsafbrydere er ude af funktion. Undgå udsættelse for stråling (d)

VARO: Avattaessa ja suo-
jalukitus ohitettaessa olet
alttiina näkymättömälle
lasersäteilylle. Älä katso
säteeseen. (f)

-
1. CLASS 1 LASER PRODUCT
 2. **DANGER:** Invisible laser radiation when open and interlock failed or defeated. Avoid direct exposure to beam.
 3. **CAUTION:** Do not open the top cover. There are no user serviceable parts inside the Unit; leave all servicing to qualified service personnel.

1. 一级雷射产品
2. **危险：**当内部锁定装置失效或者损坏后，打开盖板可能会产生不可见的雷射幅射。应避免受到光束直接照射。
3. **注意：**请勿打开顶盖板。本机内部没有用户可自行维修的部件；所有维修工作应由有资格的人员完成。

Introduction

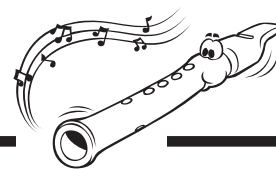

We would like to thank you for purchasing one of our JVC products. Before operating this unit, read this manual carefully and thoroughly to obtain the best possible performance from your unit, and retain this manual for future reference.

About This Manual

This manual is organized as follows:

- **The manual mainly explains operations using the buttons and controls on the unit. You can also use the buttons on the remote control if they have the same or similar names (or marks) as those on the unit. If operation using the remote control is different from that using the unit, it is then explained.**
- Basic and common information that is the same for many functions is grouped in one place, and is not repeated in each procedure. For instance, we do not repeat the information about turning on/off the unit, setting the volume, changing the sound effects, and others, which are explained in the section “Common Operations” on pages 9 to 11.
- The following marks are used in this manual:



Gives you warnings and cautions to prevent damage or risk of fire/electric shock. Also gives you information which is not good for obtaining the best possible performance from the unit.



Gives you information and hints you had better know.

Precautions

Installation

- Install in a place which is level, dry and neither too hot nor too cold — between 5°C (41°F) and 35°C (95°F).
- Install the unit in a location with adequate ventilation to prevent internal heat built-up in the unit.
- Leave sufficient distance between the unit and the TV.
- Keep the speakers away from the TV to avoid interference with TV.



DO NOT install the unit in a location near heat sources, or in a place subject to direct sunlight, excessive dust or vibration.

Power sources

- When unplugging from the wall outlet, always pull the plug, not the AC power cord.



DO NOT handle the AC power cord with wet hands.

Moisture condensation

Moisture may condense on the lens inside the unit in the following cases:

- After starting heating in the room
 - In a damp room
 - If the unit is brought directly from a cold to a warm place
- Should this occur, the unit may malfunction. In this case, leave the unit turned on for a few hours until the moisture evaporates, unplug the AC power cord, and then plug it in again.

Others

- Should any metallic object or liquid fall into the unit, unplug the unit and consult your dealer before operating any further.
- If you are not going to operate the unit for an extended period of time, unplug the AC power cord from the wall outlet.



DO NOT disassemble the unit since there are no user serviceable parts inside.

If anything goes wrong, unplug the AC power cord and consult your dealer.

Contents

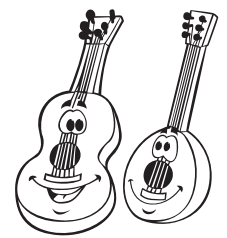

Location of the Buttons and Controls	3	Playing Back Tapes	20
Front Panel	3	Playing Back a Tape	20
Remote Control	5	Recording	21
Getting Started	6	Recording a Tape on Deck B	21
Unpacking	6	Dubbing Tapes	22
Putting the Batteries into the Remote Control	6	CD Synchronized Recording	22
Connecting Antennas	6	Using the Microphones	23
Connecting Speakers	7	Singing Along (Karaoke)	23
Connecting Other Equipment	8	Microphone Mixing	23
Adjusting the Voltage Selector	8	Using Multiplex Discs	
Cancelling the Display Demonstration	8	— Multiplex Sound (MPX)	24
Common Operations	9	Adjusting Key Control	24
Turning On or Off the Power	9	Using the Timers	25
Setting the Clock	9	Using Daily Timer	25
Selecting the Sources	10	Using Recording Timer	26
Setting the AM Tuner Interval Spacing	10	Using Sleep Timer	27
Adjusting the Volume	10	Timer Priority	27
Reinforcing the Bass Sound	11	Maintenance	28
Selecting the Sound Modes	11	Troubleshooting	29
Listening to FM and AM Broadcasts	12	Specifications	30
Tuning in a Station	12		
Presetting Stations	12		
Tuning in a Preset Station	12		
Playing Back Discs	13		
Loading Discs	13		
Playing Back the Entire Discs			
— Continuous Play	13		
Basic Disc Operations	14		
Programming the Playing Order of the Tracks			
— Program Play	14		
Playing at Random — Random Play	15		
Repeating Tracks or Discs — Repeat Play	15		
Prohibiting Disc Ejection — Tray Lock	15		
Playing Video CDs	16		
Special Plays for Video CDs	16		
Playing Video CDs with PBC Function	18		

Location of the Buttons and Controls

Become familiar with the buttons and controls on your unit.

Front Panel

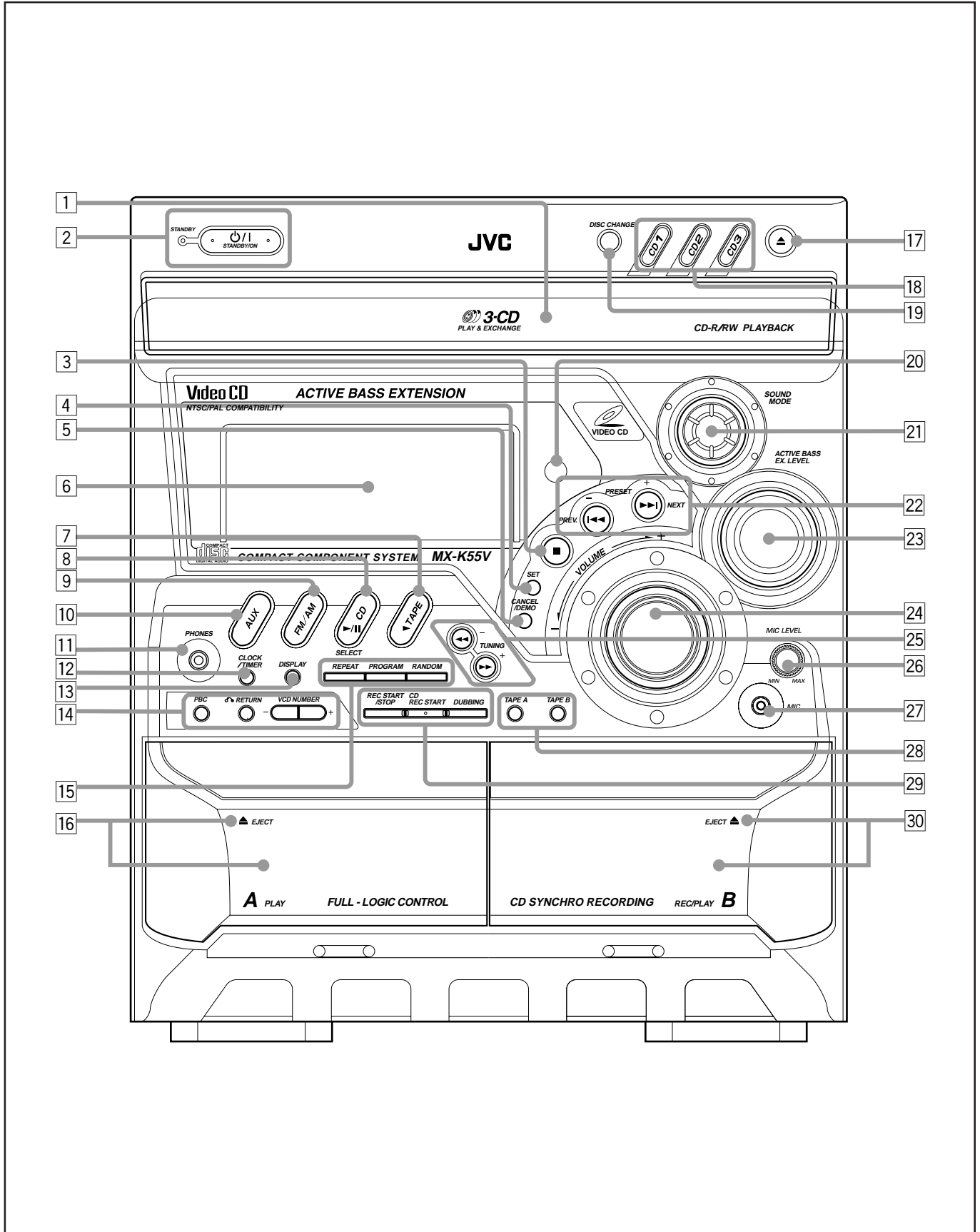

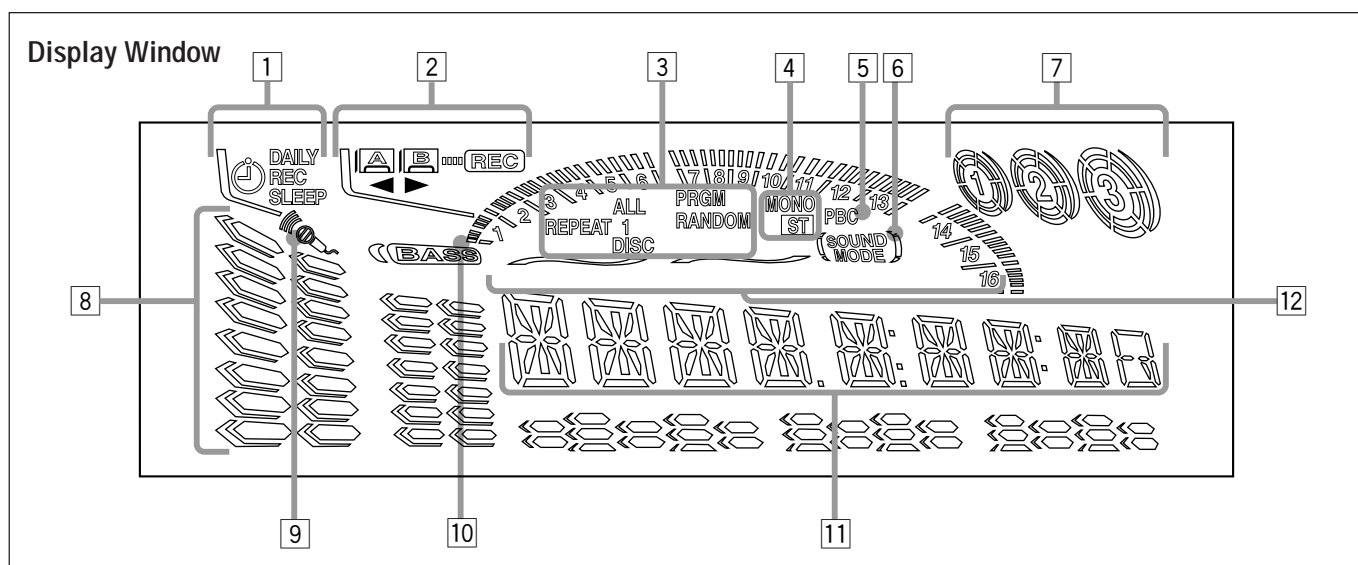

See pages in the parentheses for details.

Front Panel

- 1 Carrousel
- 2 O/I STANDBY/ON button and STANDBY lamp (9, 26, 27)
- 3 \blacksquare (stop) button (13 – 23)
- 4 SET button (9, 12, 14, 25 – 27)
- 5 CANCEL button (9, 15, 25, 26)
DEMO button (8)
- 6 Display window
- 7 TAPE \blacktriangleright button and lamp (10, 20, 22)
Pressing this button also turns on the unit.
- 8 CD $\blacktriangleright/\text{II}$ (play/pause) button and lamp (10, 13 – 15)
Pressing this button also turns on the unit.
SELECT button (18, 19)
- 9 FM/AM button and lamp (10, 12)
Pressing this button also turns on the unit.
- 10 AUX button and lamp (10)
Pressing this button also turns on the unit.
- 11 PHONES jack (10)
- 12 CLOCK/TIMER button (9, 25 – 27)
- 13 DISPLAY button (9)
- 14 PBC button (18, 19)
 O RETURN button (18, 19)
VCD NUMBER +/- buttons (18, 19)
- 15 REPEAT button (15)
PROGRAM button (14)
RANDOM button (15)
- 16 Deck A cassette holder (20, 22)
• Pressing the \blacktriangle EJECT portion opens the holder.
- 17 \blacktriangle (Carrousel open/close) button (13 – 16)
Pressing this button also turns on the unit.
- 18 Disc number buttons and lamps (CD1, CD2, and CD3) (13, 14, 17 – 19, 22)
Pressing one of these buttons also turns on the unit.
- 19 DISC CHANGE button (13, 14)
- 20 Remote sensor
- 21 SOUND MODE control (11)

- 22 PRESET +/- buttons (12)
 \lll / \ggg (reverse search/forward search) buttons (9, 14, 16, 25 – 27)
PREV. (previous) / NEXT buttons (18, 19)
- 23 ACTIVE BASS EX. LEVEL control (11)
- 24 VOLUME control (10)
- 25 TUNING +/- buttons (12)
 \lll / \ggg (fast rewind/fast forward) buttons (10, 14, 16, 20)
- 26 MIC LEVEL control (23)
- 27 MIC jack (23)
- 28 TAPE A button (16, 20)
• This button also functions as NTSC/PAL button.
TAPE B button (20)
- 29 REC START/STOP button (21)
CD REC START button (22)
DUBBING button (22)
- 30 Deck B cassette holder (20 – 22)
• Pressing the EJECT \blacktriangle portion opens the holder.

Display window

- 1 Timer indicators
• DAILY (daily timer), REC (recording timer), SLEEP (sleep timer), and O (timer) indicators
- 2 Tape operation indicators
• A/B (operating deck), REC (recording), and $\blacktriangleleft / \blacktriangleright$ (tape running) indicators
- 3 Disc play mode indicators
• REPEAT (1, 1 DISC, ALL DISC), PRGM (program), and RANDOM indicators
- 4 Tuner operation indicators
• MONO and ST (stereo) indicators
- 5 PBC indicator
- 6 SOUND MODE indicator
- 7 Disc indicators
- 8 Volume level, Bass level, and Sound Mode pattern indicators
- 9 Karaoke (O) and echo (O) indicators
- 10 BASS and its level indicators
- 11 Main display
• Shows the source name, frequency, etc.
- 12 Disc track number indicators



Remote Control

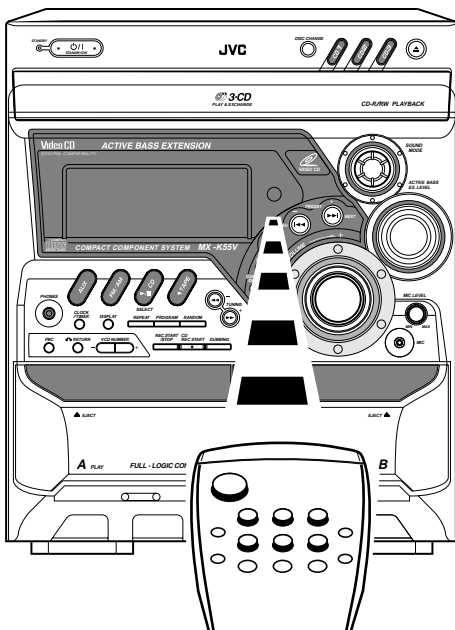
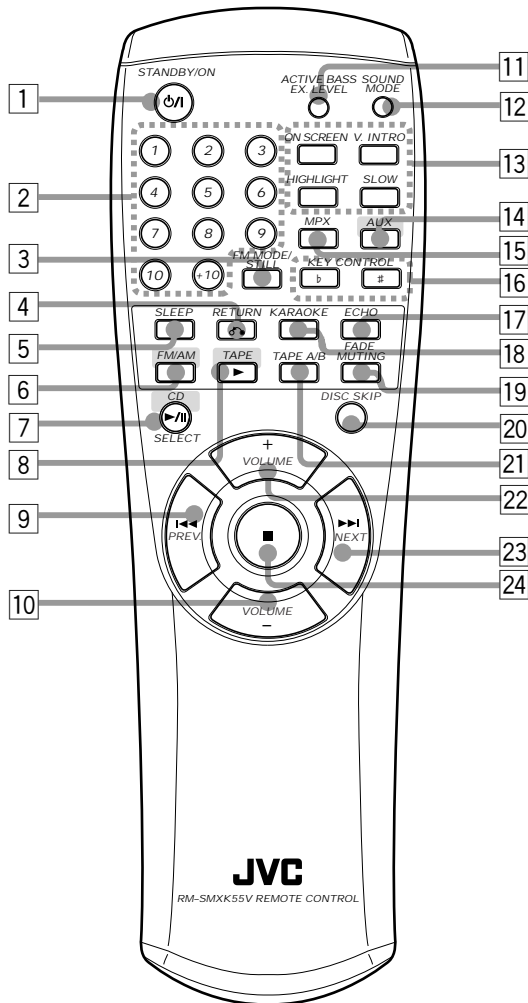

When using the remote control, point it at the remote sensor on the front panel.

Remote Control

- 1 STANDBY/ON button (9)
- 2 Number buttons (12, 14, 17)
- 3 FM MODE button (12)
STILL button (17)
- 4 RETURN button (18, 19)
- 5 SLEEP button (27)
- 6 FM/AM button (10, 12)
Pressing this button also turns on the unit.
- 7 CD button (10, 13 – 15)
Pressing this button also turns on the unit.
SELECT button (18, 19)
- 8 TAPE button (10, 20, 22)
Pressing this button also turns on the unit.
- 9 (fast rewind/reverse search) button (12, 14, 16, 20)
PREV. (previous) button (18, 19)
- 10 VOLUME – button (10)
- 11 ACTIVE BASS EX. LEVEL button (11)
- 12 SOUND MODE button (11)
- 13 VCD operating buttons
ON SCREEN button (17)
V. INTRO button (17)
HIGHLIGHT button (17)
SLOW button (16)
- 14 AUX button (10)
Pressing this button also turns on the unit.
- 15 MPX button (24)
- 16 KEY CONTROL **b** / # buttons (24)
- 17 ECHO button (23)
- 18 KARAOKE button (23)
- 19 FADE MUTING button (10)
- 20 DISC SKIP button (13, 14)
- 21 TAPE A/B button (20)
- 22 VOLUME + button (10)
- 23 (fast forward/forward search) button (12, 14, 16, 20)
NEXT button (18, 19)
- 24 (stop) button (13 – 23)

Unpacking

After unpacking, check to be sure that you have all the following items.
The number in the parentheses indicates the quantity of the pieces supplied.

- AM loop antenna (1)
- FM antenna (1)
- Remote control (1)
- Batteries (2)
- Video cord (1)
- AC plug adaptor (1)

If any is missing, consult your dealer immediately.

Putting the Batteries into the Remote Control

Insert the batteries — UM-4/AAA/IEC R03 — into the remote control, by matching the polarity (+ and -) on the batteries with the + and - markings on the battery compartment.

When the remote control can no longer operate the unit, replace both batteries at the same time.

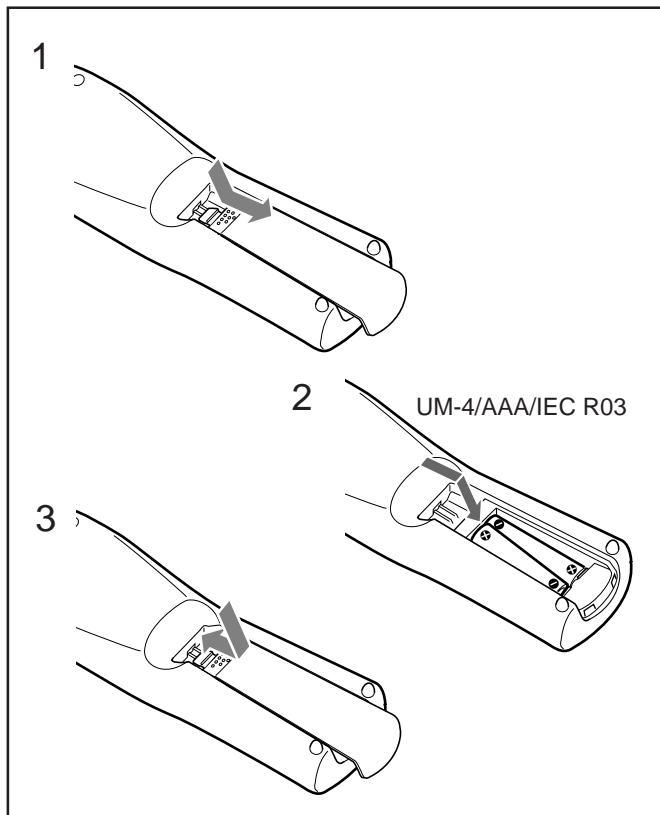

- DO NOT use an old battery together with a new one.
- DO NOT use different types of batteries together.
- DO NOT expose batteries to heat or flame.
- DO NOT leave the batteries in the battery compartment when you are not going to use the remote control for an extended period of time. Otherwise, it will be damaged from battery leakage.

Connecting Antennas

FM antenna

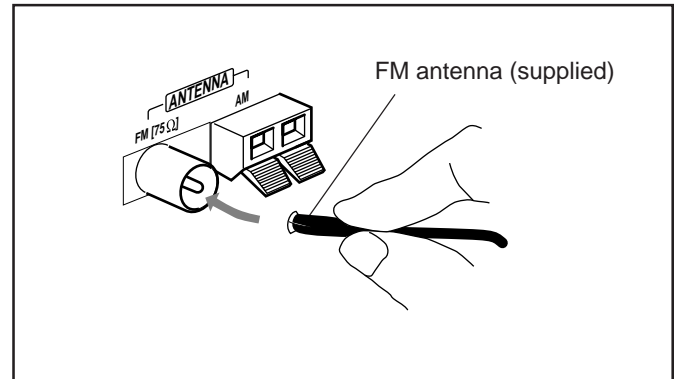

- 1 Attach the FM antenna to the FM [75 Ω] coaxial terminal.
- 2 Extend the FM antenna.
- 3 Fasten it up in the position which gives you the best reception, then fix it on the wall, etc.



About the supplied FM antenna

The FM antenna supplied with this unit can be used as temporary measure. If reception is poor, you can connect an outdoor FM antenna.

To connect an outdoor FM antenna

Before connecting it, disconnect the supplied FM antenna.

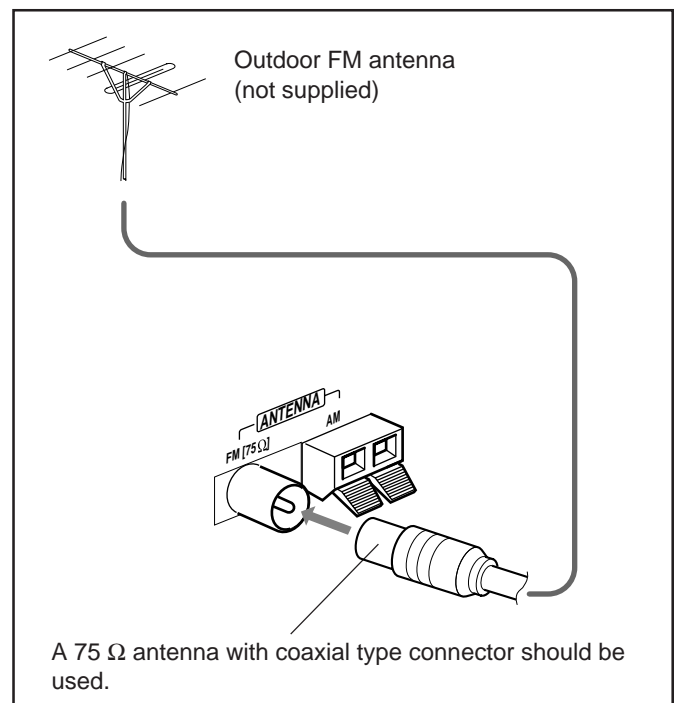

AM antenna

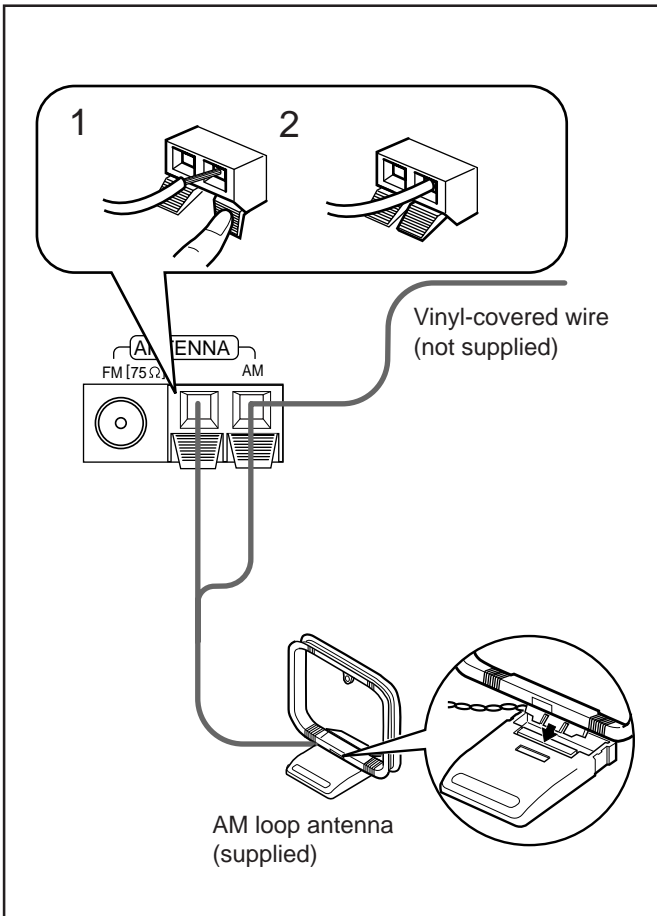

- 1 Press and hold the clamp of the AM terminal on the rear of the unit.
- 2 Insert the end of the AM loop antenna cord into the terminal.
- 3 Release the finger from the clamp.
- 4 Turn the AM loop antenna until you have the best reception.

To connect an outdoor AM antenna

When reception is poor, connect a single vinyl-covered wire to the AM terminal and extend it horizontally. (The AM loop antenna must remain connected.)

**For better reception of both FM and AM**

- Make sure the antenna conductors do not touch any other terminals and connecting cords.
- Keep the antennas away from metallic parts of the unit, connecting cords, and the AC power cord.

Connecting Speakers

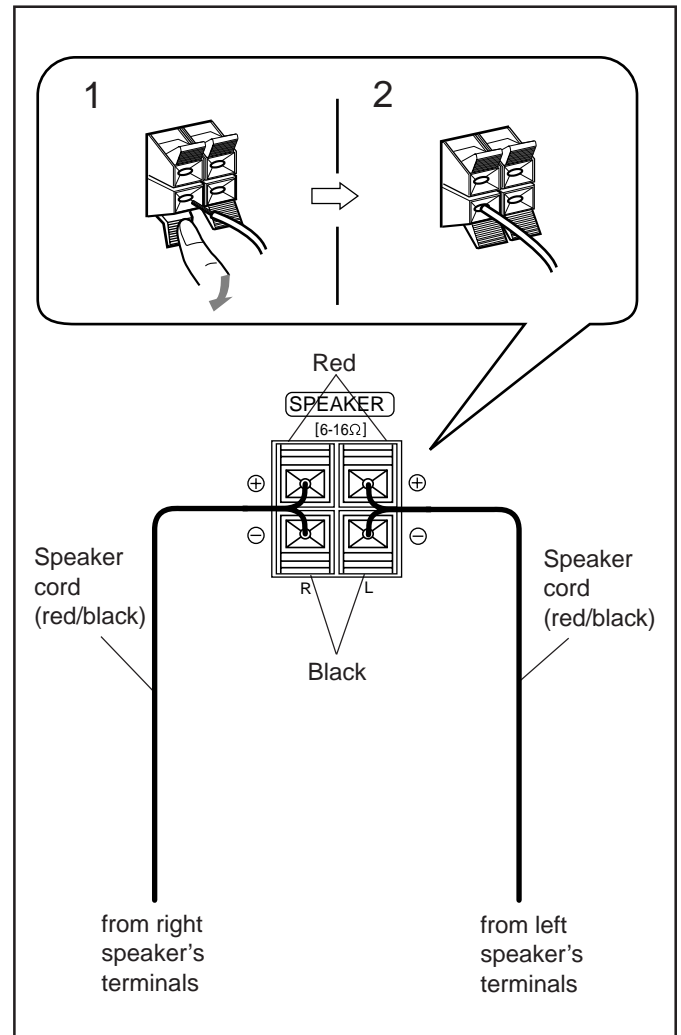

- 1 Press and hold the clamp of the speaker terminal on the rear of the unit.
- 2 Insert the end of the speaker cord into the terminal.
Match the polarity (colors); Red (+) to red (+) and black (-) to black (-).

- 3 Release the finger from the clamp.

IMPORTANT: Use only speakers with the same speaker impedance as indicated by the speaker terminals on the rear of the unit.



Connecting Other Equipment

You can connect conventional audio equipment and TV.



- DO NOT connect any equipment while the power is on.
- DO NOT plug in any equipment until all connections are complete.

To connect an analog component

Be sure that the plugs of the audio cords are color coded: White plugs and jacks are for left audio signals, and red ones for right audio signals.

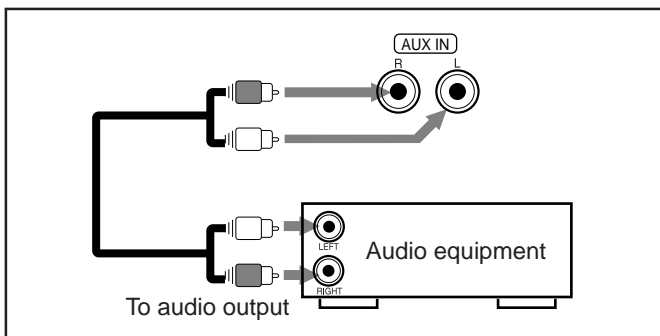

Connect the audio output jacks on the other equipment and the AUX IN jacks by using audio cords (not supplied).

To connect the TV

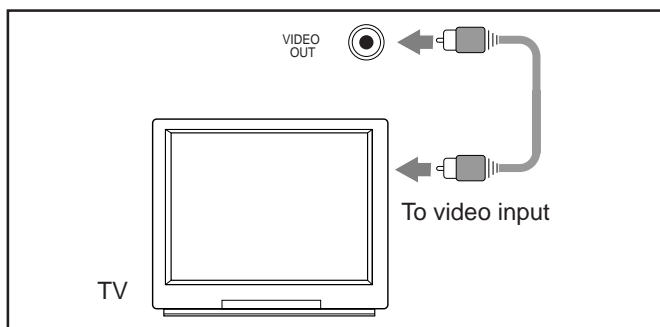

Connect the video input jacks and the VIDEO OUT jack on the rear using a video cord (supplied.)

Adjusting the Voltage Selector

Before plugging in the unit, set the correct voltage for your area with the voltage selector on the rear of the unit.



- DO NOT plug in before setting the voltage selector on the rear of the unit and all connection procedures are complete.

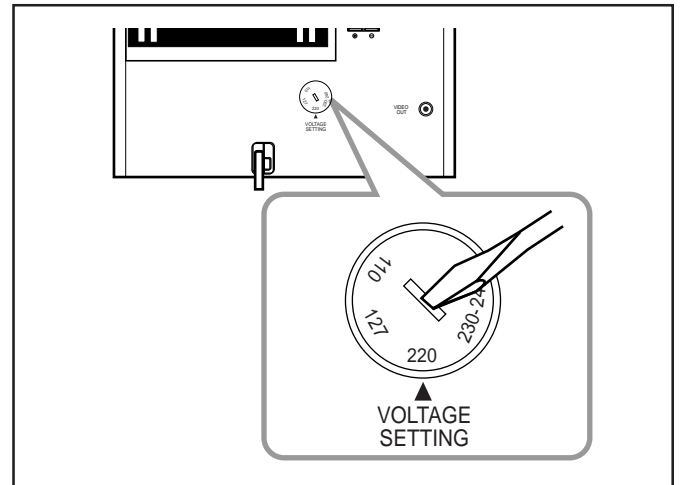

Using a screw driver, set the voltage selector so that the arrow on printed on the rear points the correct voltage where you use this unit. (See the back cover page.)

NOW, you can plug in the unit and other connected equipment FINALLY!

Canceling the Display Demonstration

When connecting the AC power cord into a wall outlet, the unit automatically starts display demonstration.

On the unit ONLY:

To cancel the display demonstration, press DEMO.

CANCEL / DEMO



When you press other buttons

The display demonstration stops temporarily. It will start automatically again (if no operation is done for 2 minutes) until you cancel it by pressing DEMO.

To start the display demonstration manually

Press and hold DEMO again for more than 2 seconds.

Common Operations

Turning On or Off the Power

To turn on the unit, press

⏻/I STANDBY/ON so that the STANDBY lamp goes off.

WELCOME

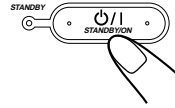

To turn off the unit (on standby), press

⏻/I STANDBY/ON again so that the STANDBY lamp lights up.

GOOD BYE

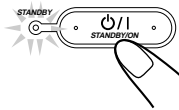

A little power is always consumed even while the unit is on standby.

To switch off the power supply completely, unplug the AC power cord from the AC outlet.



When you unplug the AC power cord or if a power failure occurs

The clock is reset to “--:--” soon, while the tuner preset stations (see page 12) will be erased in a few days.

Setting the Clock

Before operating the unit any further, first set the clock built in this unit. You can set the clock whether the unit is on or off.

On the unit ONLY:

1 Press CLOCK/TIMER.

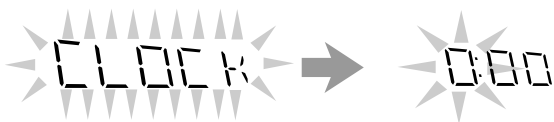

The hour digits start flashing on the display.



2 Press |◀◀ or ▶▶| to adjust the hour, then press SET.

19:00

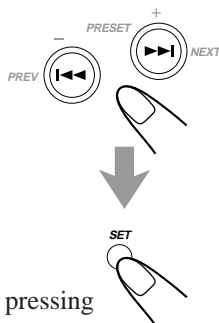

- If you want to correct the hour after pressing SET, press CANCEL. The hour digits start flashing again.

3 Press |◀◀ or ▶▶| to adjust the minute, then press SET.

CLOCK OK

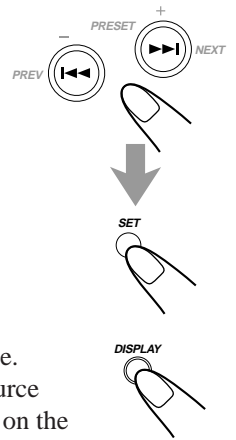

To check the clock time

Press DISPLAY while playing any source.

- Each time you press the button, the source indication and the clock time alternate on the display.

To adjust the clock again

If you have adjusted the clock before, you need to press CLOCK/TIMER repeatedly until “CLOCK” is selected.

- Each time you press the button, the clock/timer setting modes change as follows:

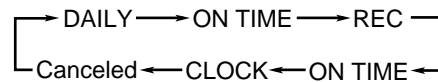

If there is a power failure

The clock loses the setting and is reset to “--:--.” You need to set the clock again.

Selecting the Sources

To listen to the FM/AM broadcasts, press FM/AM. (See page 12.)

To play back discs, press CD ►/II. (See pages 13 – 19.)

To play back tapes, press TAPE ►. (See page 20.)

To select the external equipment as the source, press AUX.

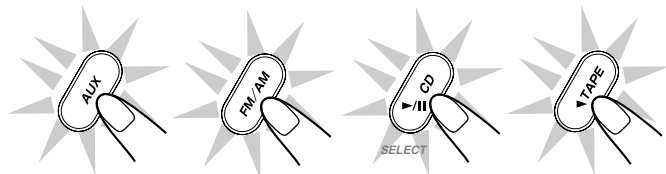

When you press the play button for a particular source (AUX, FM/AM, CD ►/II, and TAPE ►), the unit turns on (and the unit starts playing the source if it is ready — COMPU PLAY CONTROL).

Setting the AM Tuner Interval Spacing

Some countries space AM stations 9 kHz apart, and some countries use 10 kHz spacing.

On the unit ONLY:

When shipped, the unit is set to 9 kHz spacing.

To select 10 kHz interval, press  STANDBY/ON while holding down ►► when the unit is in standby mode. “AM -- 10” appears on the display.

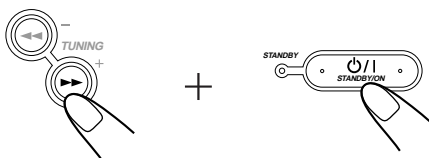

To change back to 9 kHz interval, press  STANDBY/ON while holding down ◀◀ when the unit is in standby mode. “AM -- 9” appears on the display.

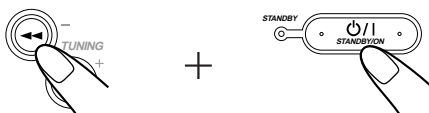

Adjusting the Volume

You can adjust the volume level only while the unit is turned on.

Turn the VOLUME control clockwise to increase the volume or counterclockwise to decrease it.

- The volume level can be adjusted in 32 steps (VOL MIN, VOL 1 — VOL 30, and VOL MAX).

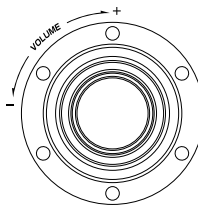

VOL 15

When using the remote control, press VOLUME + to increase the volume or press VOLUME – to decrease it.



For private listening

Connect a pair of headphones to the PHONES jack. No sound comes out of the speakers. Be sure to turn down the volume before connecting or putting on headphones.



DO NOT turn off (on standby) the unit with the volume set to an extremely high level; otherwise, a sudden blast of sound can damage your hearing, speakers and/or headphones when you turn on the unit or start playing any source next time. REMEMBER you cannot adjust the volume level while the unit is on standby.

To turn down the volume level temporarily

Press FADE MUTING on the remote control. The volume level gradually decreases to “VOL MIN.”

To restore the sound, press the button again.



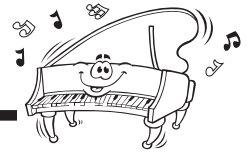

Reinforcing the Bass Sound

This function only affects the playback sound, but does not affect your recording.

The ACTIVE BASS EX. (extension) LEVEL control provided for this unit can maintain the richness and fullness of the bass sound while listening to any source at low volume.

Turn the ACTIVE BASS EX. LEVEL control clockwise to increase the bass sound or counterclockwise to decrease it.

- The bass sound level can be adjusted in 3 steps (LOW, MID, HIGH).

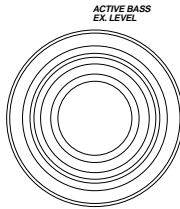

BASS indicator lights up when the Active Bass Extension is turned on.

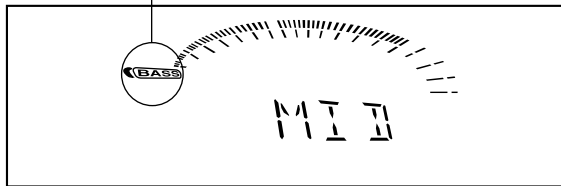

When using the remote control, press ACTIVE BASS EX. LEVEL to adjust the bass sound level. The Active Bass Extension level changes as LOW → MID → HIGH → OFF → (back to the beginning).

To cancel the Active Bass Extension, turn the control counterclockwise until “OFF” appears.

Selecting the Sound Modes

This function only affects the playback sound, but does not affect your recording.

You can select one of the 6 preset sound modes (3 surround modes and 3 SEA — Sound Effect Amplifier — modes).

To select the sound modes, turn the SOUND MODE control until the sound mode you want appears on the display.

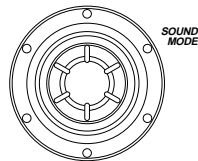

SOUND MODE indicator also lights up on the display.



- As you turn the control, the sound modes change as follows:

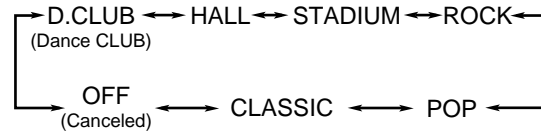

Surround modes*:

D.CLUB: Increases resonance and bass.

HALL: Adds depth and brilliance to the sound.

STADIUM: Adds clarity and spreads the sound, like in an outdoor stadium.

SEA (Sound Effect Amplifier) modes:

ROCK: Boosts low and high frequency. Good for acoustic music.

POP: Good for vocal music.

CLASSIC: Good for classical music.

OFF: Cancels the sound mode.

- * Surround elements are added to the SEA elements to create a being-there feeling in your room.

When one of these modes is selected, the SOUND MODE indicator lights up as — **(SOUND MODE)**

While one of the SEA modes (SEA elements without surround elements) is selected, the SOUND MODE indicator lights up as — **SOUND MODE**

When using the remote control, press SOUND MODE to adjust the sound mode.

- Each time you press the button, the sound modes change as follows:

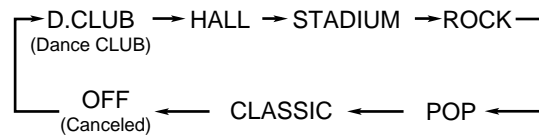

Listening to FM and AM Broadcasts



Before operating the tuner, make sure you have selected the correct AM spacing intervals (see page 10).

Tuning in a Station

1 Press FM/AM.

The unit automatically turns on and tunes in the previously tuned station (either FM or AM).

- Each time you press the button, the band alternates between FM and AM.



2 Start searching for stations.

On the unit:

Press and hold TUNING + or TUNING – for more than 1 second.

On the remote control:

Press and hold ◀◀ or ▶▶ for more than 1 second.

The unit starts searching for stations and stops when a station of sufficient signal strength is tuned in. If a program is broadcasted in stereo, the ST (stereo) indicator lights up.

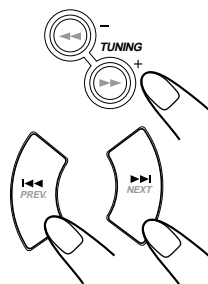

To stop during searching, press TUNING + or TUNING – (or ◀◀ or ▶▶ on the remote control).



When you press TUNING + or TUNING – (or ◀◀ or ▶▶ on the remote control) briefly and repeatedly

The frequency changes step by step.

To change the FM reception mode

When an FM stereo broadcast is hard to receive or noisy, press FM MODE on the remote control so that “MONO” appears and the MONO indicator also lights up on the display. Reception improves.



To restore the stereo effect, press FM MODE again so that “STEREO” appears on the display and the MONO indicator goes off from the display.

In this stereo mode, you can hear stereo sounds when a program is broadcasted in stereo.

Presetting Stations

You can preset 30 FM and 15 AM stations.

In some cases, test frequencies have been already memorized for the tuner since the factory examined the tuner preset function before shipment. This is not a malfunction. You can preset the stations you want into memory by following the presetting method.

- There is a time limit in doing the following steps. If the setting is canceled before you finish, start from step 1 again.

On the unit ONLY:

1 Tune in the station you want to preset.

- See “Tuning in a Station” on the left column.

FM 87.50

2 Press SET.

SET

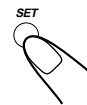

3 Press PRESET + or PRESET – to select a preset number.

P-01

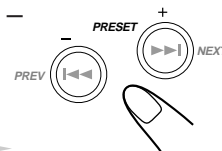

4 Press SET again.

STORED

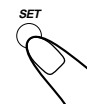

The tuned station in step 1 is stored in the preset number selected in step 3.

- Storing a new station on a used number erases the previously stored one.



When you unplug the AC power cord or if a power failure occurs

The preset stations will be erased in a few days. If this happens, preset the stations again.

Tuning in a Preset Station

1 Press FM/AM.

The unit automatically turns on and tunes in the previously tuned station (either FM or AM).

- Each time you press the button, the band alternates between FM and AM.

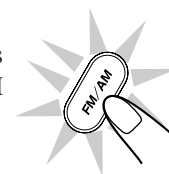

2 Select a preset number.

On the unit:

Press PRESET + or PRESET –.

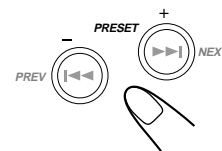

On the remote control:

Press the number buttons.

Ex.: For preset number 5, press 5.

For preset number 15, press +10, then 5.

For preset number 20, press +10, then 10.

For preset number 25, press +10, +10, then 5.

For preset number 30, press +10, +10, then 10.

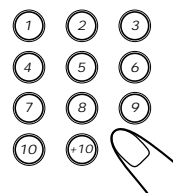

Playing Back Discs

This unit has been designed to playback the following CDs: Audio CD, Video CD, CD-R, and CD-RW.

Continued use of irregular shape discs (heart-shape, octagonal, etc.) can damage the unit.

When playing a CD-R or CD-RW

User-edited CD-Rs (Recordable) and CD-RWs (Rewritable) can be played back only if they are already "finalized."

- You can play back your original CD-Rs or CD-RWs recorded in music CD format. (However, they may not be played back depending on their characteristics or recording conditions.)
- Before playing back CD-Rs or CD-RWs, read their instructions or cautions carefully.
- Some CD-Rs or CD-RWs may not be played back on this unit because of their disc characteristics, damage or stain on them, or if the player's lens is dirty.
- CD-RWs may require a longer readout time. (This is caused by the fact that the reflectance of CD-RWs is lower than for regular CDs.)

Loading Discs

Whenever you press **▲**, the source automatically changes to CD.

1 Press **▲**.

The unit automatically turns on and the carousel comes out.



2 Place one or two discs correctly on the front slots of the carousel, with its label side up.

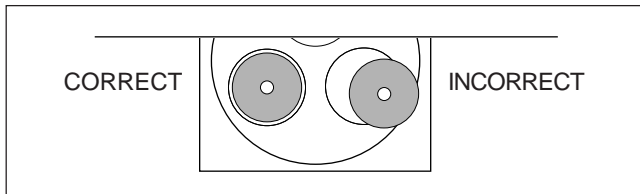

- When using a CD single (8 cm), place it on the inner circle of the disc tray.

3 If you wish to load a third disc, press **DISC CHANGE** on the unit or **DISC SKIP** on the remote control.

The carousel rotates by 120°.



4 Press **▲** again.

The carousel closes.



About the disc indicators

Each disc indicator corresponds to the disc tray of the same number.

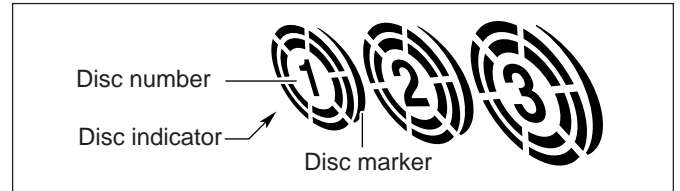

- The disc marker lights up for the disc number you have selected.
- The disc indicator rotates while the corresponding disc is being played.
- The disc indicator goes off when the unit has detected that there is no disc on the corresponding disc tray.

Playing Back the Entire Discs — Continuous Play

You can play discs continuously.

1 Load discs.

2 Press one of the disc number buttons (CD1, CD2 or CD3) for the disc you want to play.

The playback starts from the first track of the selected disc.

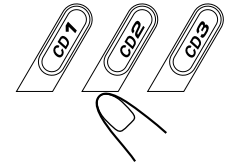

Track number of the currently playing disc is flashing. (Track numbers exceeding 16 are not displayed.)

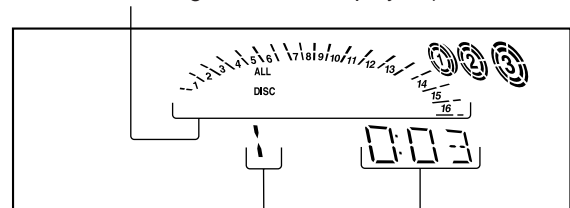

Track number Elapsed playing time

- Pressing **CD ►/||** instead of the disc number buttons starts playing back if a disc is on the tray.

When you turn on the unit, **ALL DISC** indicator lights up on the display automatically. If you do not want all the discs to play back, select **1 DISC** by pressing **REPEAT**.

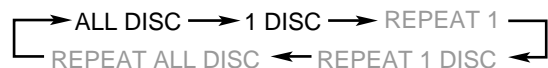

- ALL DISC:** Plays all loaded discs.
- 1 DISC:** Plays back one disc.

To stop during play, press **■**.

To remove the disc, press **▲**.



Disc playback sequence (when ALL DISC is selected)

- When 3 discs are loaded on the disc trays, they are played in one of the following sequences.
- When CD1 is pressed : CD1 ⇒ CD2 ⇒ CD3 (then stops)
 - When CD2 is pressed : CD2 ⇒ CD3 ⇒ CD1 (then stops)
 - When CD3 is pressed : CD3 ⇒ CD1 ⇒ CD2 (then stops)
- * When only 2 discs are loaded, they are played in the same order, but the disc tray without a disc is skipped.

Basic Disc Operations

While playing a disc, you can do the following operations.

To exchange discs during playback of another

Press DISC CHANGE to change the disc, and the carrousel comes out. If you change discs during play, the current play will not stop until all discs you have changed are played.



To close the carrousel, press DISC CHANGE or .

To skip to the another disc in the carrousel

Press DISC SKIP on the remote control.







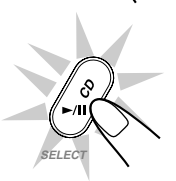

To stop play for a moment

Press CD . While pausing, "PAUSE" appears on the display.





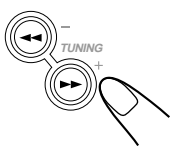

To resume play, press CD  again.

To locate a particular point in a track



During play, press and hold  or .
 • : Fast reverses the track.
 • : Fast forwards the track.
 When using the remote control, press and hold  or .

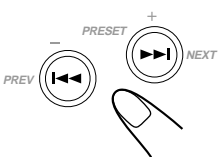

To go to another track

Press  or  repeatedly before or during playback.
 • : Goes back to the beginning of the current or previous tracks.
 • : Skips to the beginning of the next or succeeding tracks.



If you press and hold  or  on the unit before or during play

You can change the tracks continuously.

To go to another track directly using the number buttons

Pressing the number button(s) before or during play allows you to start playing the track number you want.
 Ex.: For track number 5, press 5.
 For track number 15, press +10, then 5.
 For track number 20, press +10, then 10.
 For track number 32, press +10, +10, +10, then 2.

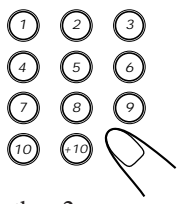



Programming the Playing Order of the Tracks — Program Play

You can arrange the order in which the tracks play before you start playing. **You can program up to 32 tracks.**

- To use Repeat play (see page 15) for Program play, press REPEAT after starting Program play.

On the unit ONLY:

1 Load discs.

- If the current playing source is not the CD player, press CD , then  before going to the next step.

2 Press PROGRAM.

The PRGM (program) indicator lights up on the display.

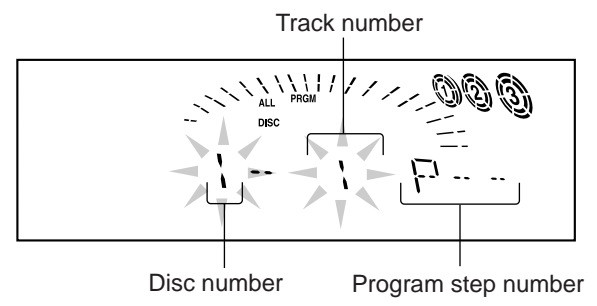
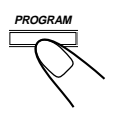

3 Press one of the disc number buttons (CD1, CD2 or CD3) to select the disc number you want to play.

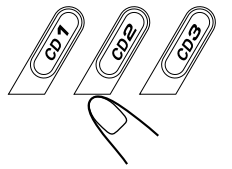

4 Press  or  to select the track number, then press SET.

Each time you select a track and press SET, the selected track number is added to the disc track number indicator.

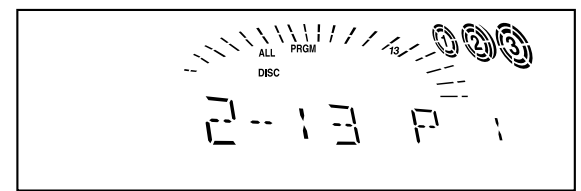
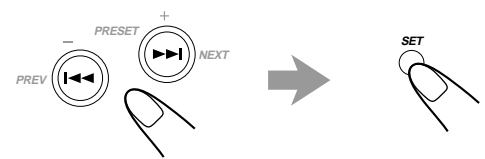

5 Program other tracks you want.

- To program tracks from the same disc, repeat step 4.
- To program tracks from a different disc, repeat steps 3 and 4.

6 Press CD ►/II.

The tracks are played in the order you have programmed.

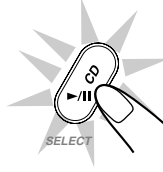

To stop during play, press ■.

To exit from Program play mode, press PROGRAM again before or after play so that the unit enters Continuous play mode.

To modify the program

Before playing, you can erase the programmed tracks shown on the display by pressing CANCEL.

- Each time you press the button, the last programmed track is erased from the program.



To check the program during play, press ►► (or ◀◀) so that the playing track will change according to the program (or reverse) order.

To add tracks in the program before play, simply select the disc numbers and/or track numbers you want to add by following steps 3 and 4 of the programming procedure on page 14.

To erase the entire program before or during play, press ■ twice.

- Ejecting a carousel, exiting from Program play mode, and turning off the unit will also erase the stored memory.



If you try to program a 33rd track

“FULL” will appear on the display.



If your entry is ignored

You have tried to program a track from an empty tray, or a track number that does not exist on the disc. Such entries are ignored.

Playing at Random — Random Play

The tracks of the selected disc will play at random.

1 Load a disc.

- If the current playing source is not the CD player, press CD ►/II, then ■ before going to the next step.

2 Press RANDOM so that “RANDOM” appears on the display.

The RANDOM indicator also lights up on the display.

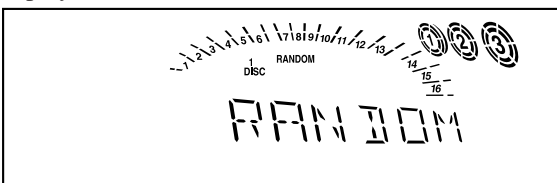

- The tracks are played automatically at random. Random play ends when all tracks are played once.

To stop during play, press ■.

- Random play also stops when ▲ is pressed.

To exit from Random play mode, press RANDOM again during play so that the unit enters Continuous play mode.

To use Random play mode, you have to exit from the Program play mode.



If you press ◀◀ or ►►

Skips to the next track selected randomly.

Repeating Tracks or Discs — Repeat Play

You can have all the discs, the program or the individual track currently playing repeat as many times as you like.

To repeat play, press REPEAT during or before playing.

- Each time you press the button, Repeat play mode changes as follows, and the following indicator lights up on the display:

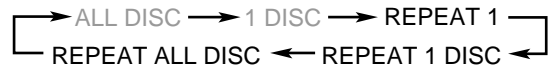
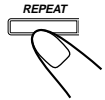

REPEAT 1: Repeats one track on one disc.

REPEAT 1 DISC*: Repeats all the tracks on one disc.

REPEAT ALL DISC: Repeats all the tracks on all the discs.

* REPEAT 1 DISC is not used for Program play.

To cancel Repeat play, press REPEAT repeatedly until the REPEAT indicator (REPEAT 1, REPEAT 1 DISC or REPEAT ALL DISC) goes off from the display.

- Repeat play and Random play cannot be used at the same time.

Prohibiting Disc Ejection — Tray Lock

You can prohibit disc ejection from the unit and lock discs.

- This operation is possible only while the unit is on and the CD player selected as the source.

On the unit ONLY:

To prohibit disc ejection, press ▲ for the carousel while holding ■.

“LOCKED” appears for a while, and the carousel is locked.

To cancel the prohibition and unlock the discs, press ▲ for the carousel while holding ■.

“UNLOCKED” appears for a while, and the carousel is unlocked.



If you try to eject discs

“LOCKED” appears to inform you that the Tray Lock is in use.

Playing Video CDs

You can play Video CDs either with or without the PBC (PlayBack Control) function.

Before playing, set video output correctly according to your TV system. Refer to “Connecting Other Equipment” on page 8.

1 Turn on the TV and select the video input so that you can view the pictures from the unit.

- Refer also to the manual supplied with your TV.

2 Prepare the discs.

- Refer to “Loading Discs” on page 13.

3 Start playback of the discs.

You can play Video CDs by using same buttons for playing audio CD both on the unit and on the Remote Control.

- Refer to “Basic Disc Operations” on page 14.

To stop during play, press ■.

To stop play and remove the disc, press ▲ for the disc being played.



Please make sure that the Video CDs to be played is not flawed optically, as this may cause a distorted sound or the unit to malfunction.

To adjust the color system — NTSC/PAL

According to a Video CD or the color system used on your TV, press TAPE A on the unit while the unit is turned off (on standby.) When you press this button for the first time, the present color system appears in the display.

Each time you press the button, the following appears in the display window.

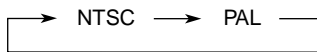

- Be sure to select either NTSC or PAL position when the picture on the TV screen appears correctly.



About the color system

When wrong position selected, picture on TV screen will lose the color and change into monochrome view.



To locate a particular point in a track

During play, press and hold ◀◀ or ▶▶.

- ◀◀: Fast reverses the track.
- ▶▶: Fast forwards the track.

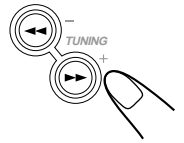

Each time you press the button, “SCAN” appears upper left on the TV screen. When using the remote control, press and hold ◀◀ or ▶▶.

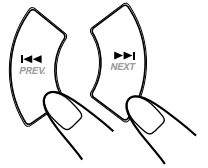

To go to another track

Press ◀◀ or ▶▶ repeatedly before or during playback.

- ◀◀: Goes back to the beginning of the current or previous tracks.
- ▶▶: Skips to the beginning of the next or succeeding tracks.

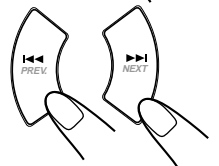
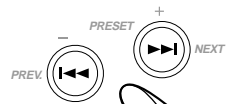

If you press and hold ◀◀ or ▶▶ on the unit before or during play

You can change the tracks continuously.

Special Plays for Video CDs

You can use the following special plays for Video CDs both with and without PBC function.

To enjoy slow motion playback

Press SLOW on the remote control during playback.

A still picture appears on the screen.

Each time you press the button, slow motion speed changes as follows:

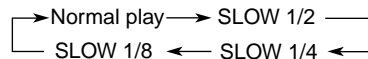

- To resume normal playback, press CD ▶/■.

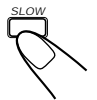

During slow motion playback

No sound comes out.

To play Still picture playback

Press **STILL** on the remote control during playback.

When you press the button, playback pauses and a still picture is shown on the TV screen.

- To resume normal playback, press **CD ▶/II**.



3 Press the number button of the video intro you want to playback.

Playback starts from the selected track.

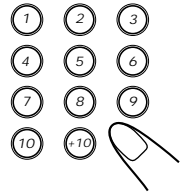

To stop and cancel the video intro, press **■**.

To view Operation Status

You can view operation status about the track being played on the TV screen.

Press **ON SCREEN** on the remote control.

The information about the disc being played are shown on TV: disc number, track number and playing time.

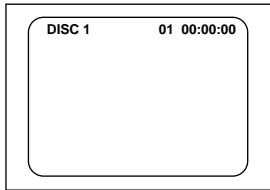

To erase operation status, press **ON SCREEN** again. All the information about the track being played disappear.

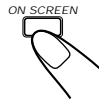

To view the Highlights of a Video CD

You can view 9 highlight scenes of the selected track on a video CD. These highlight scenes are created by dividing the track equally into 9 portions and the beginning (5 seconds each) of those 9 scenes are shown on the TV screen.

- For a video CD with PBC function, cancel the PBC function. Refer to “Playing Video CDs without Using Menu Screen” on page 19.

1 Press one of the disc number buttons (CD1, CD2 or CD3) on the unit and the number button of the track you want to view the highlights.

Playback starts.

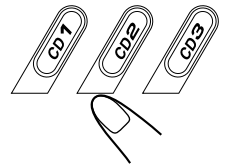

2 Press HIGHLIGHT after a picture appears on the TV screen.

The highlight starts and shows in sequence (the first 5 seconds of nine divided highlight scenes) on the TV screen.



To view the Video Intro of a Video CD

You can view contents of a video CD, the first 5 seconds of each track on the disc.

- For a video CD with PBC function, cancel the PBC function. Refer to “Playing Video CDs without Using Menu Screen” on page 19.

1 Press one of the disc number buttons (CD1, CD2 or CD3) on the unit to select the disc you want to view the video intro.

Playback starts.

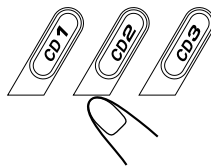

2 Press V.INTRO after a picture appears on the TV screen.

The video intro starts and shows in sequence (the first 5 seconds of nine tracks) on the TV screen. If the disc consists more than 9 tracks, remaining tracks are shown after the first 9 tracks finish showing.

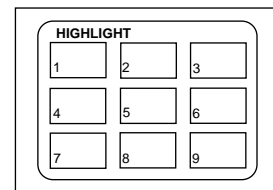
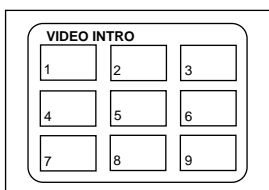
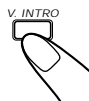

3 Press the number button of the highlight scene you want to playback.

Playback starts from the beginning of the selected scene.

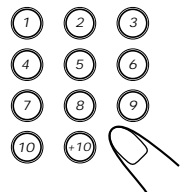

To stop and cancel the highlight, press **■**.



During video intro or highlight play

The picture shown on the TV screen may be partially distorted, resulting from noises or incorrect manufacturing of the disc.

Playing Video CDs with PBC Function

The PBC (Playback Control) function allows you to enjoy menu-driven operation and high resolution still pictures.



This unit is designed for playback of video CDs, version 1.1 and 2.0. Only with version 2.0, you can call up "on screen menu" function. This unit will not play back any other video CDs other than 1.1 and 2.0 versions.

Menu-driven operation

You can interact with the TV screen using menu screens to select and play items of the disc.

High-resolution still pictures

You can view high-resolution still pictures having quality four times higher than playback pictures.

Playing Video CDs with Using Menu Screens

When you start playing a video CD with the PBC function, a selection menu appears on the TV screen. This menu shows a list of items to select and play.

- The playback operation procedure may differ depending on the disc you use.

Button controls:

VCD NUMBER + or -

Select a specific menu item from the TV screen or the monitor.

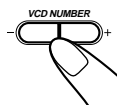

PREV. ◀◀ or NEXT ▶▶

Move through menu screens.

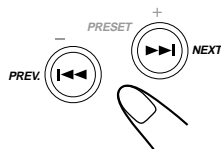

CD ▶/|| SELECT

When "SELECT XX" appears on the TV screen, pressing this button jumps to the selected picture or program.

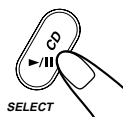

RETURN

Press the button once, return to the previous menu or screen.



■ (stop)

Press and hold the button for a few seconds, quit the operation of the video CDs.

PBC

Each time you press the button, PlayBack Control function is set to on/off. When you change the function, video CDs program automatically starts again from the beginning of selected function.

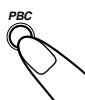

- You cannot call up menu screen by pressing this button.

1 Turn on the TV and select the video input so that you can view the pictures from the unit.

Refer also to the manual supplied for your TV.

2 Prepare Video CDs.

Refer to "Loading Discs" on page 13.

"VCD/CD" appears and then "PBC" indicator lights on the display.

3 Start playback of the Video CD.

Press CD ▶/|| SELECT to start playback of the currently selected disc or press CD1, CD2 or CD3 to select the disc and start playback.

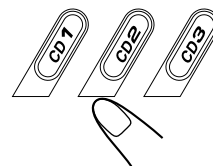
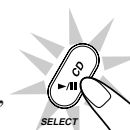

4 Select the item you want to playback when a selection menu appears on the TV.

Press VCD NUMBER + or - to select the item number. Then press CD ▶/|| SELECT to start the playback.

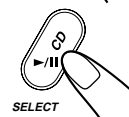
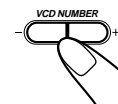



Basic Flow of Menu Play Operation

Some discs may show moving pictures or divided screens.

- When a list of items appears, you can select the item you want to play back by pressing VCD NUMBER + or – repeatedly. For example, “SELECT 01” appears on the screen and “SEL-01 ” on the display.
- When moving picture appears, you can select a moving picture by either pressing PREV. ◀◀◀ or NEXT ▶▶▶ or pressing CD ▶/|| SELECT after selecting the item number by VCD NUMBER + or – while the moving picture you want to view is being played back. “SELECT XX” appears on the screen.
- When a menu appears after the item you selected has finished playing, you can select another number of the item you want to view next.
- If the video CD has more than 2 pages of menu, you can view the remaining items by pressing NEXT ▶▶▶. If you want to go back to the previous menu, press PREV. ◀◀◀.
- After playback, press ⏪ RETURN to go back to the previous screen. Each time you press the button, you can go back to the previous screen up to the beginning of the program one by one.
- If you want to stop Menu Play, press ■ for more than 2 seconds. Some discs may return you to the menu screen shown before playback.

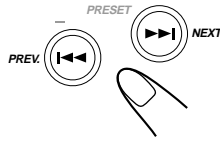
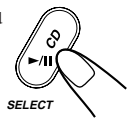
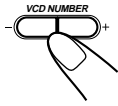

Playing Video CDs without Using Menu Screen

You can cancel the PBC function and play the disc without using menu screen.

1 Turn on the TV and select the video input so that you can view the pictures from the Unit.
Refer also to the manual supplied for your TV.

2 Prepare a Video CD.
Refer to “Loading Discs” on page 13.

3 Start playback of the Video CD.
Press the CD ▶/|| SELECT to start playback of the currently selected disc or press the CD1, CD2 or CD3 to select the disc and start playback.

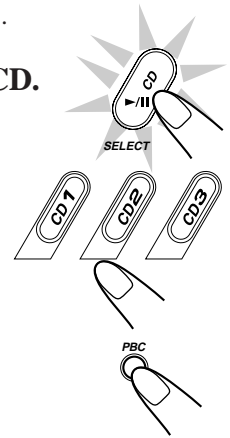

4 Press PBC on the unit.

To stop during playback, press ■. The PBC function restores automatically.



When the PBC function is canceled, some pictures, such as still pictures, may not be played back.



If “NEXT” or “PREVIOUS” is shown on the TV screen (for some Video CDs it may be hidden or illustrated),

you can move to the next or previous screen by pressing NEXT ▶▶▶ or PREV. ◀◀◀. By pressing ⏪ RETURN, you can also go back to the previous screen, the opening menu screen, or some other screen (this depends on how the Video CD has been programmed.)

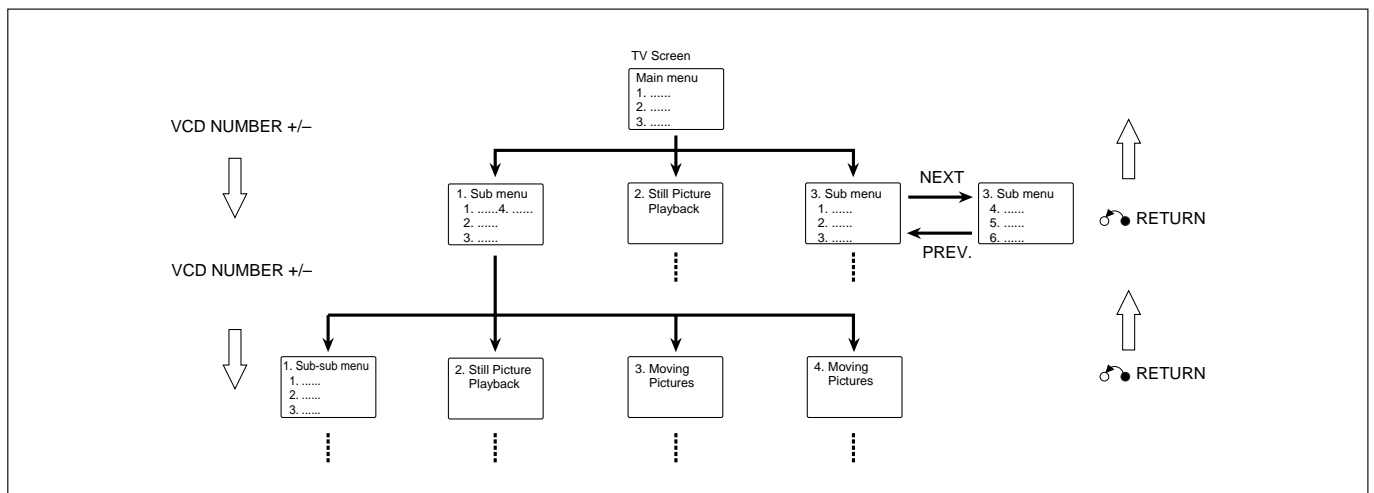



Playing Back Tapes

Playing Back a Tape

1 Press EJECT (▲) for the deck you want to use.

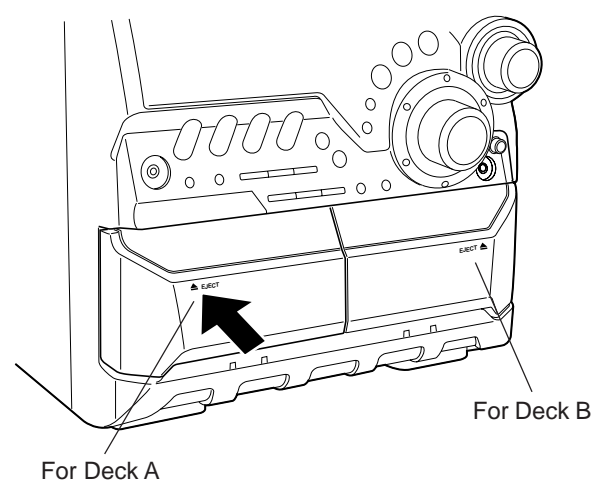

To stop during play, press ■.

To operate the other deck, press TAPE A or TAPE B (or TAPE A/B on the remote control), then TAPE ►.

To fast-forward the tape, press ►► (or ►►| on the remote control). The tape direction indicator (►) starts flashing quickly.

To rewind the tape, press ◀◀ (or |◀◀ on the remote control). The tape direction indicator (◀) starts flashing quickly.

To remove the cassette, press ▲ EJECT for deck A or EJECT ▲ for deck B.

2 Put a cassette in with the exposed part of the tape down.

- You can play back only type I.

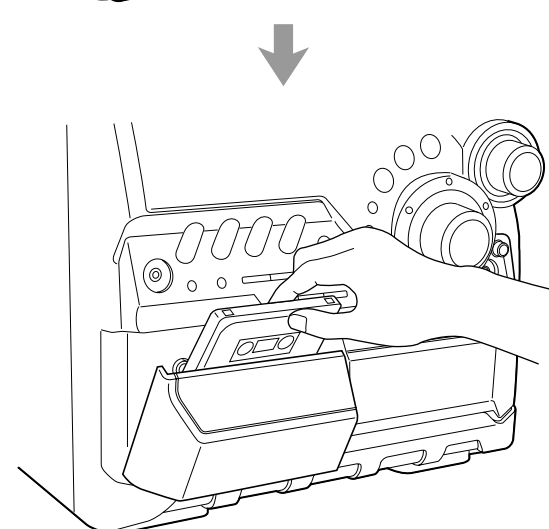
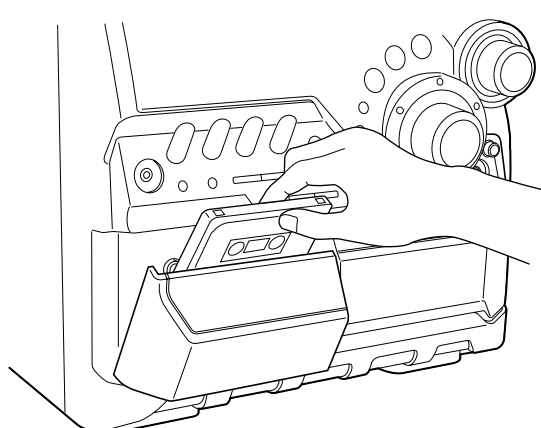
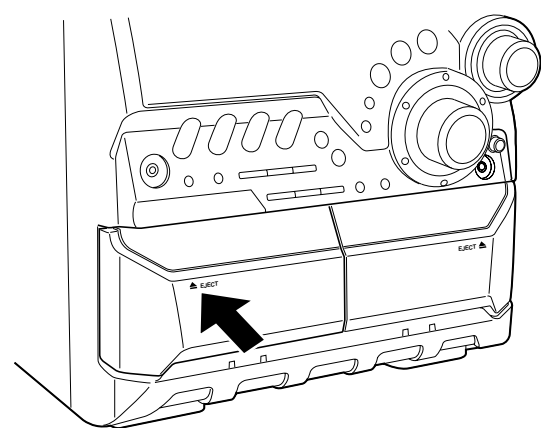

3 Close the cassette holder gently.

If you put cassettes in both decks A and B, the last deck which you have put a cassette into is selected.

To operate the other deck, press TAPE A or TAPE B (or TAPE A/B on the remote control).

4 Press TAPE ►.

The tape play starts and the tape running indicator (►) starts flashing slowly.

When the tape plays to the end, the deck automatically stops.

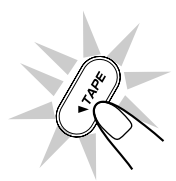

STOP! The use of the C-120 or thinner tape is not recommended, since characteristic deterioration may occur and this tape easily jams in the pinch rollers and the capstans.

Recording

IMPORTANT:

- It may be unlawful to record or play back copyrighted material without the consent of the copyright owner.
- The recording level is automatically set correctly, so it is not affected by the VOLUME control, the SOUND MODE control, and the ACTIVE BASS EX. LEVEL control. Thus, during recording you can adjust the sound you are actually listening to without affecting the recording level.
- While recording, you can hear sound modes through the speakers or headphones. However, the sound is recorded without these effects (see page 11).
- If recordings you have made have excessive noise or static, the unit may be too close to a TV. Place the unit away from the TV.
- You can use type I tape for recording.

To protect your recording

Cassettes have two small tabs on the back to protect unexpected erasure or re-recording.



To protect your recording, remove these tabs.

To re-record on a protected tape, cover the holes with adhesive tape.

To keep the best recording and playback sound quality

If the heads, capstans, and pinch rollers of the cassette decks become dirty, the following will occur:

- Impaired sound quality
- Discontinuous sound
- Fading
- Incomplete erasure
- Difficulty in recording

To clean the head, capstan, and pinch roller

Use a cotton swab moistened with alcohol.

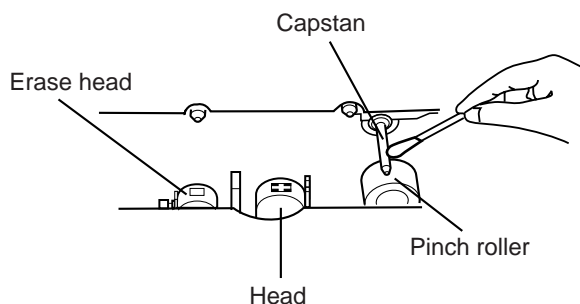

To demagnetize the head

Turn off the unit, and use a head demagnetizer (available at electronics and record shops).

Recording a Tape on Deck B

On the unit ONLY:

1 Press EJECT ▲ for the deck B.

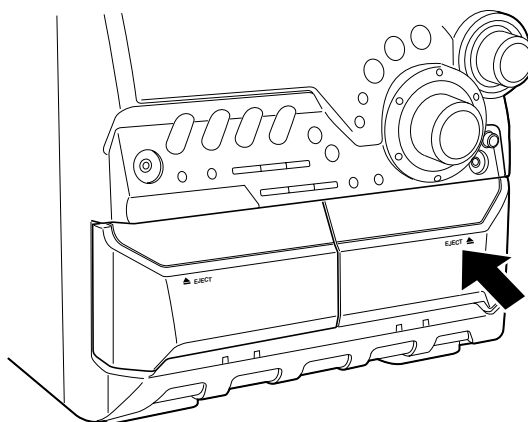

2 Put a recordable cassette in with the exposed part of the tape down.

3 Close the cassette holder gently.

4 Start playing the source — FM, AM, CD player or auxiliary equipment connected to AUX IN jacks.

- When you want to use the dubbing method, see “Dubbing Tapes” on page 22.
- When the source is CD, you can also use CD Synchronized Recording (see “CD Synchronized Recording” on page 22.)

5 Press REC START/STOP.

The REC (recording) indicator lights up on the display and recording starts.



To stop during recording, press REC START/STOP again or ■.

To remove the cassette, press EJECT ▲ for deck B.



Dubbing Tapes

On the unit ONLY:

1 Press TAPE ►, then ■.

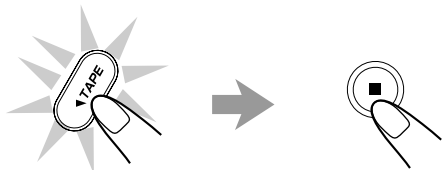

2 Put the source cassette into deck A, and a recordable cassette into deck B.

3 Press DUBBING.

Dubbing starts.
“DUBBING” appears, and the REC (recording) indicator lights up on the display.

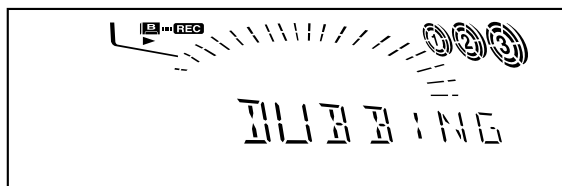

To stop during dubbing, press ■.

To remove the cassette, press ▲ EJECT for deck A and EJECT ▲ for deck B.

CD Synchronized Recording

You can easily record a CD onto a tape.

- You can also record the tracks in order you have made the program.

On the unit ONLY:

1 Put a recordable cassette into deck B.

2 Place a disc correctly on the circle of the disc tray, with its label side up.

3 Press one of the disc number buttons (CD1, CD2 or CD3) to select the disc, then ■.

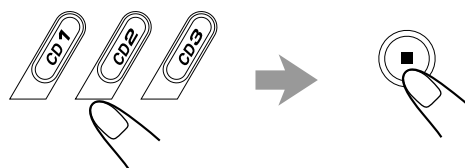

4 Press CD REC START.

“CD REC” appears, and the REC (recording) indicator lights up on the display.

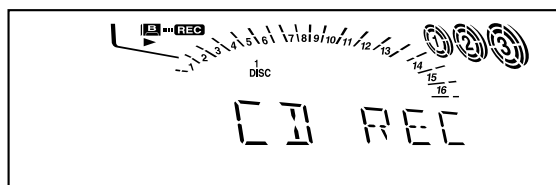
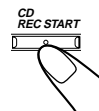

Deck B starts recording and the CD player starts playing.
When the recording is done, the CD player and deck B stop.

To stop during CD Synchronized Recording, press ■.

To remove the cassette, press EJECT ▲ for deck B.

Using the Microphones

You can enjoy singing along (Karaoke) and microphone mixing.

IMPORTANT:

- Always set the MIC LEVEL to MIN when connecting or disconnecting the microphone.
- When you do not use the microphone, keep the microphones unconnected.

If howling or squealing (feedback) occurs while using the microphone, take the following actions to prevent these noises.

- Adjust the MIC LEVEL and VOLUME controls.
- Avoid pointing the microphone towards the speakers.

Singing Along (Karaoke)

You can enjoy singing along (Karaoke) using Vocal Masking. Vocal Masking reduce the lead vocal of the playing source while playing back a source.

- This function cannot be used for multiplex discs or tapes.

1 Rotate MIC LEVEL to MIN.



2 Connect the microphone (not supplied) by plugging it into the MIC jack.

The karaoke indicator (🎤) lights up on the display.

3 Start playing the source — CD, tape or other connected component.

4 Press KARAOKE on the remote control.

“V.MASK” appears on the display for a few seconds.



5 Rotate MIC LEVEL and VOLUME controls as you sing into the microphone.

When you finish singing, cancel the Karaoke function by pressing KARAOKE.

- By pressing REC START/STOP, you can record your singing along if you want. (For more details, see page 21.)
- To stop during recording, press ■.

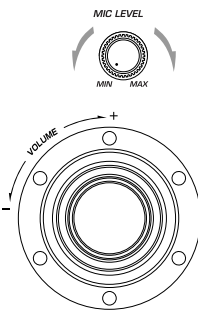

If you use the following sources as the playing source for Vocal Masking, you cannot get the satisfactory results

- Radio programs — a radio signal is not as reliable as the signals coming from a tape, CD or VCD.
- Monaural sources.
- Poorly dubbed tapes.
- Sources recorded with duets, strong echo, a chorus, or only a few instruments.

To apply an echo to your voice

Press ECHO on the remote control so that the echo (🎤) indicator lights up on the display.

Each time you press the button, the echo level changes as follows:

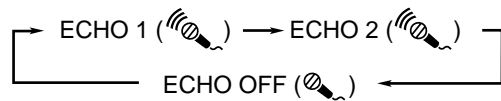

As the number increases, a stronger echo effect applies to your voice.

Microphone Mixing

When you use microphone with any playback source, follow the procedure below.

1 Rotate MIC LEVEL to MIN.



2 Connect the microphone (not supplied) by plugging it into the MIC jack.

3 Start playing the source — CD, tape or other connected component.

4 Rotate MIC LEVEL and VOLUME controls as you sing into the microphone.

- By pressing REC START/STOP, you can record your singing along if you want. (For more details, see page 21.)
- To stop during recording, press ■.

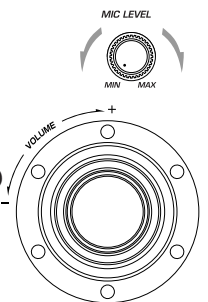



Using Multiplex Discs — Multiplex Sound (MPX)

In a multiplex karaoke disc, the instrumental part is recorded on the left channel and the vocal part is recorded on the right channel. By using Multiplex Sound (MPX) function, you can select the channel to play back.

- This function cannot be used for multiplex karaoke tapes.

On the remote control ONLY:

1 Press MPX during play.

- Each time you press the button, output sound changes as follows:



Lch MONO: Only the left channel (instrumental parts) is played back through both the right and left speakers.

Rch MONO: Only the right channel (vocal parts) is played back through both the right and left speakers.

STEREO: Cancels the Multiplex Sound (MPX) (normal stereo playback resumes).



When you finish enjoying Karaoke

Cancel the Multiplex Sound (MPX) function; otherwise, normal playback will not be possible.

Adjusting Key Control

You can adjust the key of the source if it's not suite on you.

- This function is available only when you use CDs or Video CDs for karaoke source.

On the remote control ONLY:

1 Start the source disc.

2 Press KEY CONTROL.

To lower the key, press KEY CONTROL **b** from "KEY 0" to "KEY -7."

To raise the key, press KEY CONTROL **#** from "KEY 0" to "KEY +7."

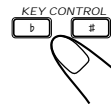

To cancel the key control, press KEY CONTROL **b** or **#** until "KEY 0" appears on the display.



If you use the key control function

- When you change the key, the key position remains unless you change it again. To restore the original key of the source, refer to "To cancel the key control" above.
- You cannot adjust the key while recording.
- When you change the source, key control function is canceled and the key returns to "KEY 0."

Using the Timers

There are three timers available — Daily Timer, Recording Timer, and Sleep Timer.

Before using the timers, you need to set the clock built in the unit. (See “Setting the Clock” on page 9.)

Using Daily Timer

With Daily Timer, you can wake to your favorite music or radio program. You can set the timer whether the unit is on or off.

How Daily Timer actually works

The unit automatically turns on, set the volume level to the preset level, and starts playing the specified source when the on-time comes (the ☺ indicator flashes while the timer is operating). Then, when the off-time comes, the unit automatically turns off (stands by).

The timer setting remains in memory until you change it.

- There is a time limit in doing the following steps. If the setting is canceled before you finish, start from step 1 again.
- If you have made a mistake while setting timer, press CANCEL. (However, this does not always work. If CANCEL does not work, press CLOCK/TIMER repeatedly and start from step 1 again.)

Before you start...

- *When using a CD as the source to play* —
– Make sure there is a CD on the currently selected disc number tray.
- *When using a tape as the source to play* —
– Make sure that a tape is in the deck whose deck indicator (A or B) is lit on the display.
- *When using the external component as the source to play* —
– Set the timer equipped with the external component at the same time.

On the unit ONLY:

1 Press CLOCK/TIMER repeatedly until “DAILY” appears on the display.

☺ indicator lights up and the DAILY (daily timer) indicator also starts flashing on the display.

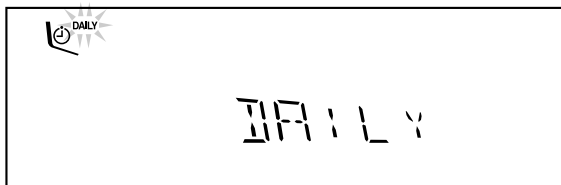

- Each time you press the button, the timer setting modes change as follows:

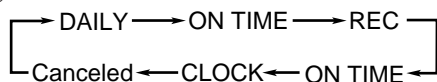

(See page 9.)

2 Press CLOCK/TIMER again.

“ON TIME” appears for 2 seconds, then the unit enters on-time setting mode.



3 Set the on-time you want the unit to turn on.

- 1) Press ◀◀ or ▶▶ to set the hour, then press SET.
- 2) Press ◀◀ or ▶▶ to set the minute, then press SET.
“OFF TIME” appears for 2 seconds, then the unit enters off-time setting mode.

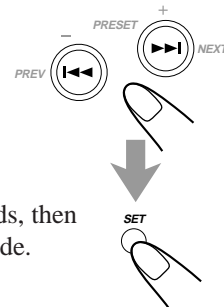

4 Set the off-time you want the unit to turn off (on standby).

- 1) Press ◀◀ or ▶▶ to set the hour, then press SET.
- 2) Press ◀◀ or ▶▶ to set the minute, then press SET.
The unit enters source selecting mode.

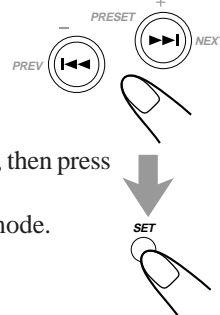

5 Press ◀◀ or ▶▶ to select the source to play, then press SET.

- Each time you press ◀◀ or ▶▶, the source changes as follows:

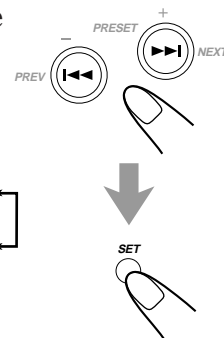

TUNER FM: tunes into a specified preset FM station.
→ go to step 6.

TUNER AM: tunes into a specified preset AM station.
→ go to step 6.

CD: plays a disc from the first track.
→ go to step 7.

TAPE: plays a tape in deck A or B. → go to step 7.

AUX: plays an external source. → go to step 7.

6 When you have selected “TUNER FM” or “TUNER AM” in step 5. Select the preset station number.

Press **◀◀** or **▶▶** to select the preset station number, then press **SET**.
The unit enters volume setting mode.

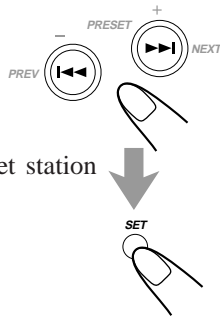

7 Press **◀◀** or **▶▶** to set the volume level.

- You can select the volume level from VOL MIN, VOL 1 — VOL 30, and VOL MAX.

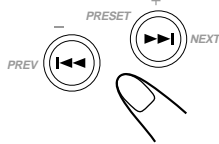
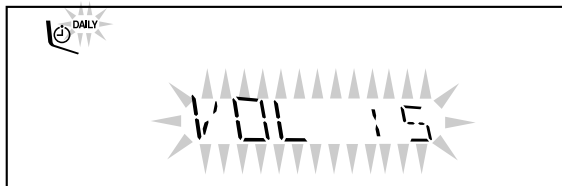

8 Press **SET** to complete the Daily Timer setting.

The **DAILY** (daily timer) indicator stops flashing and remains lit. The settings you have done are shown on the display in sequence for your confirmation.

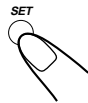

9 Press **⏻/STANDBY/ON** to turn off the unit (on standby) if you have set the Daily Timer with the unit turned on.

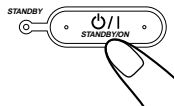

If the unit is turned on when the timer-on time comes Daily Timer does not work.

To turn on or off Daily Timer after its setting is done

1 Press **CLOCK/TIMER** repeatedly until “**DAILY**” appears on the display.



2 To turn off the Daily Timer, press **CANCEL**.

The **DAILY** (daily timer) indicator goes off from the display (“**OFF**” appears for a while). The Daily Timer is canceled, but the setting for the Daily Timer remains in memory.



To turn on the Daily Timer, press **SET**.

The **DAILY** (daily timer) indicator lights up on the display. The settings you have done are shown on the display in sequence for your confirmation.

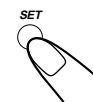

Using Recording Timer

With Recording Timer, you can make a tape of a radio broadcast automatically. You can set the timer whether the unit is on or off.

How Recording Timer actually works

The unit automatically turns on, tunes into the specified station, sets the volume level to “VOL MIN,” and starts recording when the on-time comes (the **⊕** indicator flashes while the timer is operating). Then, when the off-time comes, the unit automatically turns off (stands by).

The timer setting remains in memory until you change it.

- There is a time limit in doing the following steps. If the setting is canceled before you finish, start from step 1 again.
- If you have made a mistake while setting the timer, press **CANCEL**. (However, this does not always work. If **CANCEL** does not work, press **CLOCK/TIMER** repeatedly and start from step 2 again.)

On the unit ONLY:

1 Put a recordable cassette into deck B.

2 Press **CLOCK/TIMER** repeatedly until “**REC**” appears on the display.

⊕ indicator lights up and the **REC** (recording timer) indicator also starts flashing on the display.



- Each time you press the button, the timer setting modes change as follows:

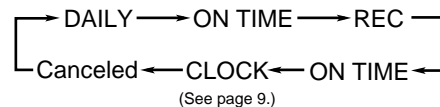

3 Press **CLOCK/TIMER** again.

“**ON TIME**” appears for 2 seconds, then the unit enters on-time setting mode.

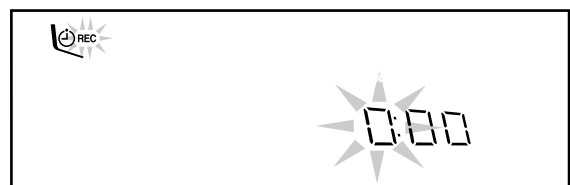



4 Set the on-time you want the unit to turn on.

- 1) Press ◀◀ or ▶▶ to set the hour, then press SET.
- 2) Press ◀◀ or ▶▶ to set the minute, then press SET.
“OFF TIME” appears for 2 seconds, then the unit enters off-time setting mode.

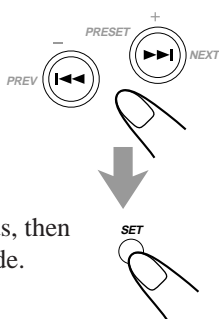

5 Set the off-time you want the unit to turn off (on standby).

- 1) Press ◀◀ or ▶▶ to set the hour, then press SET.
- 2) Press ◀◀ or ▶▶ to set the minute, then press SET.
The unit enters preset station selecting mode.

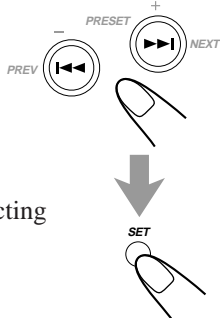

6 Select the preset station.

- 1) Press ◀◀ or ▶▶ to select the band (“TUNER FM” or “TUNER AM”), then press SET.
- 2) Press ◀◀ or ▶▶ to select a preset channel number, then press SET.
The REC (recording timer) indicator stops flashing and remains lit. The settings you have done are shown on the display in sequence for your confirmation.

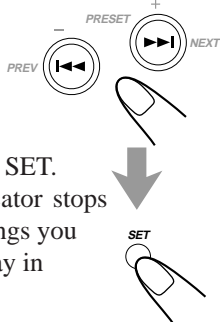

7 Press ⏻/STANDBY/ON to turn off the unit (on standby) if necessary.

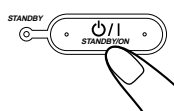

If you want to listen to another source while recording Press REC START/STOP or ■ to stop recording. Without stopping it, you cannot change the source.

To turn on or off Recording Timer after its setting is done

- 1 Press CLOCK/TIMER repeatedly until “REC” appears on the display.



- 2 To turn off the Recording Timer, press CANCEL.

The REC (recording timer) indicator goes off from the display (“OFF” appears for a while). The Recording Timer is canceled, but the setting for the Recording Timer remains in memory.



To turn on the Recording Timer, press SET.
The REC (recording timer) indicator lights up on the display. The settings you have done are shown on the display in sequence for your confirmation.

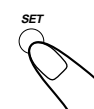

Using Sleep Timer

With Sleep Timer, you can fall asleep to music. You can set Sleep Timer when the unit is turned on.

How Sleep Timer actually works

The unit automatically turns off after the specified time length passes.

On the remote control ONLY:

1 Press SLEEP.

The time length until the shut-off time appears and the SLEEP indicator starts flashing on the display.



- Each time you press the button, the time length changes as follows:

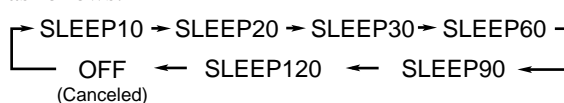

2 Wait for about 5 seconds after specifying the time length.

The SLEEP indicator stops flashing and remains lit.

To check the remaining time until the shut-off time, press SLEEP once so that the remaining time until the shut-off time appears for about 5 seconds.

To change the shut-off time, press SLEEP repeatedly until the desired time length appears on the display.

To cancel the setting, press SLEEP repeatedly until “OFF” appears on the display so that the SLEEP indicator goes off from the display.

- Sleep Timer is also canceled when you turn off the unit.

Timer Priority

Since each timer can be set separately, you may wonder what happens if the setting for these timers overlaps. Here are examples.

- **Recording Timer has priority over Daily Timer.**

If Daily Timer is set to come on while Recording Timer is operating, Daily Timer will not come on at all.

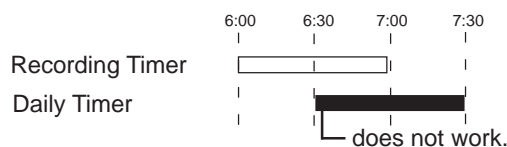

- If Sleep Timer overlaps with another timer (either Daily Timer or Recording Timer), a timer with the earlier shut-off time has priority.

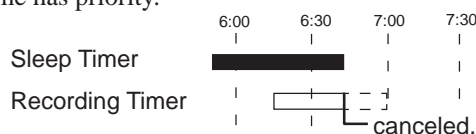

When using the Recording Timer and Sleep Timer at the same time, pay special attention to the shut-off time.

Maintenance



To get the best performance of the unit, keep your discs, tapes, and mechanism clean.

Handling discs



- Remove the disc from its case by holding it at the edge while pressing the center hole lightly.
- Do not touch the shiny surface of the disc, or bend the disc.
- Put the disc back in its case after use to prevent warping.

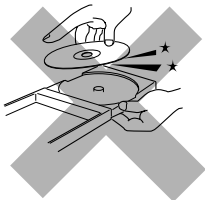

- Be careful not to scratch the surface of the disc when placing it back in its case.
- Avoid exposure to direct sunlight, temperature extremes, and moisture.



To clean the disc

Wipe the disc with a soft cloth in a straight line from center to edge.

Handling cassette tapes

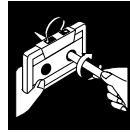

- If the tape is loose in its cassette, take up the slack by inserting a pencil in one of the reels and rotating.
- If the tape is loose, it may get stretched, cut, or caught in the cassette.

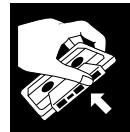

- Be careful not to touch the tape surface.



- Avoid the following places to store the tape:
 - In dusty places
 - In direct sunlight or heat
 - In moist areas
 - Near a magnet



DO NOT use any solvent — such as conventional record cleaner, spray, thinner, or benzine — to clean the disc.

Troubleshooting



If you are having a problem with your unit, check this list for a possible solution before calling for service.

If you cannot solve the problem from the hints given here, or the unit has been physically damaged, call a qualified person, such as your dealer, for service.

Symptom	Cause	Action
Unable to cancel the display demonstration.	Other buttons are pressed to cancel the display demonstration.	Press DEMO on the unit. (See page 8.)
No sound is heard.	Connections are incorrect or loose.	Check all connections and make corrections. (See pages 6 to 8.)
Hard to listen to broadcasts because of noise.	<ul style="list-style-type: none"> • Antennas are disconnected. • The AM loop antenna is too close to the unit. • The FM antenna is not properly extended and positioned. 	<ul style="list-style-type: none"> • Reconnect the antennas correctly and securely. • Change the position and direction of the AM loop antenna. • Extend the FM antenna at the best position.
The disc sound is discontinuous.	The disc is scratched or dirty.	Clean or replace the disc. (See page 28.)
The carousel does not open or close.	<ul style="list-style-type: none"> • The AC power cord is not plugged in. • The carousel is locked. 	<ul style="list-style-type: none"> • Plug the AC power cord. • Unlock the carousel. (See page 15.)
The disc does not play.	The disc is placed upside down.	Place the disc with the label side up.
The cassette holders cannot be opened.	Power supply from the AC power cord has been cut off while the tape was running.	Turn on the unit.
Impossible to record.	Small tabs on the back of the cassette are removed.	Cover the holes with adhesive tape.
Stereo effect is lost.	Vocal Masking is activated.	Cancel the Vocal Masking. (See page 23.)
Operations are disabled.	The built-in microprocessor may malfunction due to external electrical interference.	Unplug the AC power cord and then plug it back in.
Unable to operate the unit from the remote control.	<ul style="list-style-type: none"> • The path between the remote control and the remote sensor on the unit is blocked. • The batteries are exhausted. 	<ul style="list-style-type: none"> • Remove the obstruction. • Replace the batteries.
The pictures of the video CD is distorted.	When you pause or advance the pictures manually, the pictures are distorted. This is not a malfunction.	

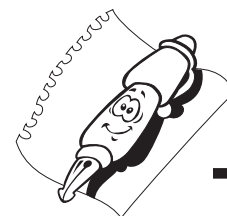

Amplifier section — CA-MXK55V

Output Power:

80 W per channel, min. RMS, driven into 6 Ω at 1 kHz with no more than 10% total harmonic distortion.

Audio input sensitivity/Impedance (at 1 kHz)

AUX: 530 mV/50 kΩ

MIC: 2.5 mV/5 kΩ

Speakers/Impedance: 6 Ω — 16 Ω

Tuner

FM tuning range: 87.50 MHz — 108.00 MHz

AM tuning range:

At 9 kHz intervals : 531 kHz — 1 602 kHz

At 10 kHz intervals : 530 kHz — 1 710 kHz

CD player

CD Capacity: 3 CDs

Dynamic range: 85 dB

Signal-to-noise ratio: 85 dB

Cassette deck

Frequency response

Normal (type I): 50 Hz — 14 000 Hz

Wow and flutter

0.15% (WRMS)

General

Power requirement: AC 110 V / AC 127 V / AC 220 V /
AC 230 V — AC 240 V \sim (adjustable with the
voltage selector), 50 Hz / 60 Hz

Power consumption: 120 W (at operation)
17 W (on standby)

Dimensions (approx.): 270 mm x 317 mm x 447 mm (W/H/D)
(10^{11/16} in. x 12^{1/2} in. x 17^{5/8} in.)

Mass (approx.): 8.6 kg (19.0 lbs)

Supplied accessories

See page 6.

Speaker section — SP-MXK55

Type: 3-way bass-reflex type

Speaker units: Woofer: 13.5 cm (5^{3/8} in.) cone x1

Midrange: 5 cm (2 in.) cone x1

Tweeter: 2 cm (1^{3/16} in.) dome x1

Power handling capacity:

90 W

Impedance: 6 Ω

Frequency range: 45 Hz — 20 000 Hz

Sound pressure level: 82 dB/W•m

Dimensions (approx.): 215 mm x 323 mm x 242 mm (W/H/D)
(8^{1/2} in. x 12^{3/4} in. x 9^{9/16} in.)

Mass (approx.): 3.3 kg (7.3 lbs) each

Design and specifications are subject to change without notice.

Mains (AC) Line Instruction (not applicable for Europe, U.S.A., Canada, Australia, and U.K.)

主（AC）电源线路说明（不适用于欧洲、美国、加拿大、澳洲及英国型号）

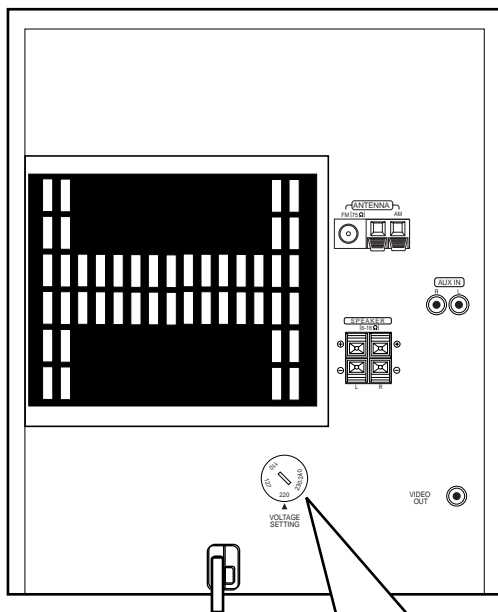

IMPORTANT for mains (AC) line

BEFORE PLUGGING IN, do check that your mains (AC) line voltage corresponds with the position of the voltage selector switch provided on the outside of this equipment and, if different, reset the voltage selector switch, to prevent from a damage or risk of fire/electric shock.

有关主（AC）电源线路的重要事项

接插电源以前，务请检查当地的主（AC）电源线路电压是否和位于本机外面的电压选择开关设定的位置一致。如果不一致，即重新设定电压选择开关使符合当地电压，以免损坏机器或引起火灾／触电的危险。

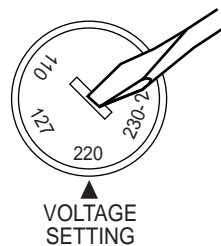

JVC
VICTOR COMPANY OF JAPAN, LIMITED